

# LAMBDA 25, 35, 45



## User's Guide



**Lambda 25, 35, 45  
User's Guide**

---



## Release History

Part Number	Release	Publication Date
09934586	A	August 2002
	B	January 2003

Any comments about the documentation for this product should be addressed to:

User Assistance  
PerkinElmer  
Chalfont Road  
Seer Green  
Beaconsfield  
Bucks HP9 2FX  
United Kingdom

User Assistance  
PerkinElmer  
710 Bridgeport Avenue  
Shelton, Connecticut 06484-4794 U.S.A.

Or emailed to: [info@perkinelmer.com](mailto:info@perkinelmer.com)

### Notices

The information contained in this document is subject to change without notice.  
**Except as specifically set forth in its terms and conditions of sale, PerkinElmer makes no warranty of any kind with regard to this document, including, but not limited to, the implied warranties of merchantability and fitness for a particular purpose.**  
PerkinElmer shall not be liable for errors contained herein for incidental consequential damages in connection with furnishing, performance or use of this material.

### Copyright Information

This document contains proprietary information that is protected by copyright. All rights are reserved. No part of this publication may be reproduced in any form whatsoever or translated into any language without the prior, written permission of PerkinElmer, Inc.

Copyright © 2003 PerkinElmer, Inc.  
Produced in the USA.

### Trademarks

Registered names, trademarks, etc. used in this document, even when not specifically marked as such, are protected by law.

PerkinElmer is a registered trademark of PerkinElmer, Inc.  
e-ssentials is a trademark of PerkinElmer, Inc.

## Table of Contents

---

Table of Contents.....	3
<b>Warnings and Safety Information .....</b>	<b>7</b>
Safety Summary .....	9
Safety Information in the Handbook .....	9
IEC 61010 Compliance .....	9
CSA Compliance .....	9
Electrical Protection .....	9
Electrical Safety.....	10
EMC Compliance .....	13
EC Directive .....	13
FCC rules and regulations .....	13
Environment .....	14
Lifting the Lambda 25, 35, 45 .....	17
Labels.....	18
<b>Introduction .....</b>	<b>21</b>
About this Manual .....	23
Conventions Used in this Manual.....	24
Definitions .....	24
Notes, cautions and warnings .....	24
Other Warnings used in this Manual .....	27
<b>System Description .....</b>	<b>35</b>
Introduction .....	37
Instruments .....	37
UV WinLab Software .....	37
Major Components .....	38
Optical System of the Lambda 25, 35, 45 .....	39
Lambda 25, 35 and 45 Specifications .....	42
General .....	42
Optics.....	43
Data Output .....	43
<b>Installation.....</b>	<b>45</b>
Installation Summary.....	47
Preparing the Laboratory .....	48
Laboratory Space Requirements.....	49
Unpacking your Instrument .....	51
Unpacking and Inspection .....	51

Equipment Provided .....	52
Installing the Instrument and the PC .....	53
Connecting the PC to the spectrometer .....	53
Connecting the Instrument to the Power Supply .....	54
Startup and Shutdown.....	55
Startup .....	55
Installing UV WinLab version 4.0 or higher .....	56
Starting UV WinLab.....	56
Shutdown.....	57
Installing the Single Cell Holder .....	58
Description .....	58
<b>Accessories.....</b>	<b>67</b>
Operating with Accessories .....	69
General .....	69
Accessories.....	69
Requirements for Operation with Accessories .....	70
Accessory Connections.....	71
Accessory Connector Panel.....	71
Accessory Connections Overview.....	73
Accessory Installation .....	73
Sample Compartment Cover .....	74
Sample Compartment Front Cover.....	74
Sample Compartment Window .....	74
Linear Transporter .....	75
Installation Overview .....	75
Temperature Sensor .....	76
Installation Overview .....	76
Sippers .....	77
Installation Overview .....	77
<b>Maintenance .....</b>	<b>79</b>
Maintenance.....	81
Obtaining Service .....	81
Cleaning the Sample Compartment.....	83
Use and Care of Cells .....	84
Cell Handling .....	84
Pressure Buildup in Cells .....	85
Replacing a Lamp .....	86
Halogen Lamp Replacement .....	87

Deuterium Lamp Replacement.....	90
Lamp Energy Attenuator.....	93
Lamp Alignment Procedure.....	95
Changing Fuses.....	96
Replacement Parts.....	98
<b>Analytical Notes.....</b>	<b>99</b>
Unusual Samples.....	101
Volatile Samples.....	101
Samples not Governed by the Beer-Lambert Law.....	101
Chemically Reactive Samples.....	102
Photoactive Samples.....	102
Other Sample Properties.....	102
Solvent Properties.....	103
<b>Index.....</b>	<b>105</b>
Index.....	107





***Warnings and  
Safety Information*** **1**

---

## **Safety Summary**

---

### ***Safety Information in the Handbook***

This handbook contains information and warnings that must be followed by the user to ensure safe operation and to maintain the instrument in a safe condition.

Possible hazards that could harm the user or result in damage to the instrument are clearly stated at appropriate places throughout this handbook.

Before using the instrument it is essential to read the manual carefully and to pay particular attention to any advice concerning potential hazards that may arise from the use of the instrument. The advice is intended to supplement, not supercede the normal safety code of behavior prevailing in the user's country.

### ***IEC 61010 Compliance***

This instrument has been designed and tested in accordance with IEC 61010-1: *Safety requirements for electrical equipment for measurement, control, and laboratory use*, and Amendment 1 to this standard.

### ***CSA Compliance***

This instrument meets the Canadian Standards Association (CSA) Standard CAN/CSA-C22.2-1010.1: *Safety Requirements for Electrical Equipment for Measurement, Control, and Laboratory Use – General Requirements*.

### ***Electrical Protection***

Insulation: Class I as defined in IEC 61010-1.

Installation Category: The instruments are able to withstand transient overvoltage according to Installation Category II as defined in IEC 61010-1 and IEC 664.

Pollution Degree: The equipment will operate safely in environments that contain non-conductive foreign matter and condensation up to Pollution Degree 2 - usually only non-conductive atmospheric pollution of the equipment occurs; occasionally, however, a temporary conductivity caused by condensation must be expected.

### **Electrical Safety**

To ensure satisfactory and safe operation of the instrument, it is essential that the green/yellow lead of the line power cord is connected to true electrical earth (ground).

If any part of the instrument is not installed by a PerkinElmer service representative, make sure that the line power plug is wired correctly:

Terminal	Cord Lead Colors	
	International	USA
Live	Brown	Black
Neutral	Blue	White
Protective Conductor (earth/ground)	Green/Yellow	Green





**Electrical Hazard**

*Any interruption of the protective conductor inside or outside the instrument or disconnection of the protective conductor (earth/ground) terminal is likely to make the instrument dangerous.*

*Intentional interruption is prohibited.*

**Lethal voltages are present in the instrument**

- *Even with the power switch OFF, line power voltages can still be present within the instrument.*
- *When the instrument is connected to line power, terminals may be live, and opening covers or removing parts (except those to which access can be gained without the use of a tool) is likely to expose live parts.*
- *Capacitors inside the instrument may still be charged even if the instrument has been disconnected from all voltage sources.*

Connect the instrument to a correctly installed line power outlet that has a protective conductor (earth/ground).

Do not attempt to make internal adjustments or replacements except as directed in this manual.

Do not operate the instrument with any covers or parts removed.

Servicing should be carried out only by a PerkinElmer service representative or similarly authorized and trained person.

Disconnect the instrument from all voltage sources before opening it for any adjustment, replacement, maintenance, or repair. If, afterwards, the opened instrument must be operated for further adjustment, maintenance, or repair, this must only be done by a skilled person who is aware of the hazard involved.

Use only fuses with the required current rating and of the specified type for replacement. Do not use makeshift fuses or short-circuit the fuse holders.

Whenever it is likely that the instrument is no longer electrically safe for use, make the instrument inoperative and secure it against any unauthorized or unintentional operation.

The instrument is likely to be electrically unsafe when it:

- Shows visible damage;
- Fails to perform the intended measurement;
- Has been subjected to prolonged storage under unfavorable conditions;
- Has been subjected to severe transport stresses.



**WARNING**

*If the equipment is used in a manner not specified herein the protection provided by the equipment may be impaired.*

**CAUTION**

*There are ventilation grills on the top cover of the instrument. Do not cover these grills.*

## ***EMC Compliance***

---

### ***EC Directive***

This product complies with the minimum immunity requirements of IEC 61326 and has been tested to the relevant parts of the following standards:

IEC 61000-4-2

IEC 61000-4-3

IEC 61000-4-4

IEC 61000-4-5

IEC 61000-4-6

IEC 61000-4-11

This product complies with EN 55011 Group 1 Class A, IEC 61000-3-2 and IEC 61000-3-3.

### ***FCC rules and regulations***

This product is classified as a digital device used exclusively as industrial, commercial, or medical test equipment. It is exempt from the technical standards specified in Part 15 of the FCC Rules and Regulations, based on Section 15.103(c).

## **Environment**

### **Operating Conditions**



**WARNING**

#### ***Explosive Atmosphere***

*This instrument is not designed for operation in an explosive atmosphere.*

The instrument will operate correctly under the following conditions:

- Indoors.
- Ambient temperature +15 °C to +35 °C.
- Ambient relative humidity 20% to 80%, without condensation.
- Altitude in the range 0 m to 2000 m.

The instrument has been designed to be safe under the following environmental conditions:

- Ambient temperatures of 5 °C to 40 °C.
- A maximum ambient relative humidity of 80% for temperatures up to 31 °C, decreasing linearly to 50% relative humidity at 40 °C.
- Altitude up to 2000 m (above mean sea level).
- Mains supply fluctuations not exceeding  $\pm 10\%$  of the nominal voltage.

When you remove the instrument from storage, before putting it into operation allow it to stand for at least a day under the approved operating conditions.



## Chemicals

Use, store, and dispose of chemicals that you require for your analyses in accordance with the manufacturer's recommendations and local safety regulations.



**WARNING**

### **Hazardous Chemicals**

*Some chemicals used with this instrument may be hazardous or may become hazardous after completion of an analysis.*

*The responsible body (for example, Laboratory Manager) must take the necessary precautions to ensure that the surrounding workplace and instrument operators are not exposed to hazardous levels of toxic substances (chemical or biological) as defined in the applicable Material Safety Data Sheets (MSDS) or OSHA, ACGIH, or COSHH documents.*

*Venting for fumes and disposal of waste must be in accordance with all national, state and local health and safety regulations and laws.*

*OSHA: Occupational Safety and Health Administration (U.S.A.)*

*ACGIH: American Conference of Governmental Industrial Hygienists (U.S.A)*

*COSHH: Control of Substances Hazardous to Health (U.K.)*

### **Toxic Fumes**

If you are working with volatile solvents or toxic substances, you must provide an efficient laboratory ventilation system to remove vapors that may be produced when you are performing analyses.

### ***Waste Disposal***

Waste containers may contain corrosive or organic solutions and small amounts of the substances that were analyzed. If these materials are toxic, you may have to treat the collected effluent as hazardous waste. Refer to your local safety regulations for proper disposal procedures.

Deuterium lamps and other spectral lamps are maintained under reduced pressure. When you dispose of lamps that are defective or otherwise unusable, handle them correctly to minimize the implosion risk.

### ***UV Radiation***

You should be aware of the health hazards presented by ultraviolet radiation.

- When the deuterium (UV) lamp is illuminated, do not open the spectrophotometer covers unless specifically instructed to do so in the manual.
- Always wear UV-absorbing eye protection when the deuterium lamp is exposed.
- Never gaze into the deuterium lamp.

## Lifting the Lambda 25, 35, 45



**WARNING**

*Consult local codes of practice issued by safety advisors before attempting to lift the instrument.*

As the Lambda 25, 35, 45 weighs approximately 26 Kg we recommend that the instrument is lifted by 2 adults, and that it is lifted by the base of the instrument.

## **Labels**

---

Labels are fixed to the Lambda 25, 35, 45 in the locations shown in Figure 1 and Figure 3.

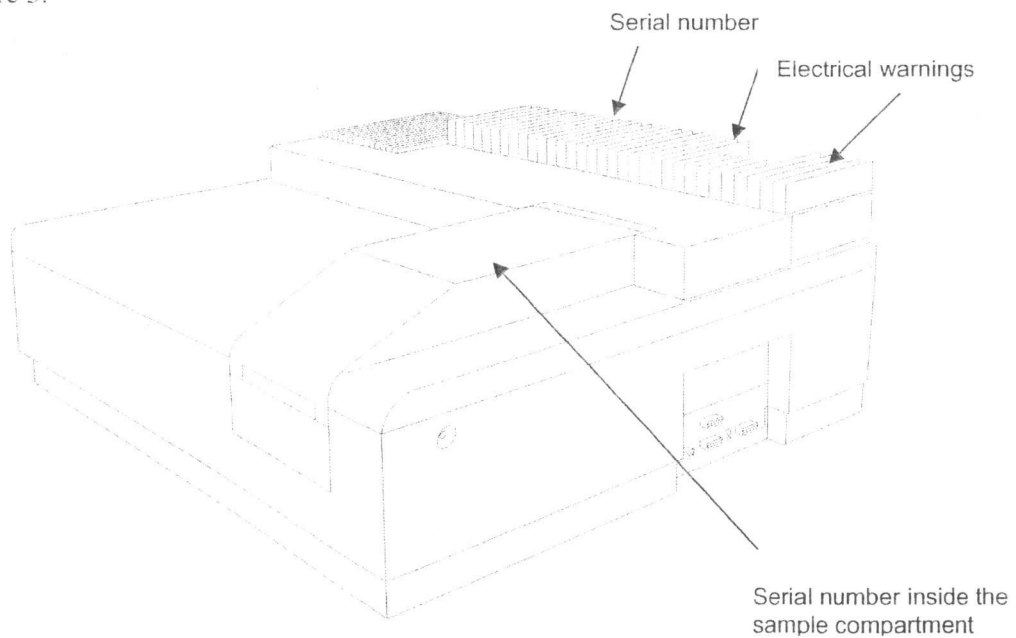

**Figure 1 Labels on the spectrometer housing**



The following electrical warnings are shown on the rear of the instrument:

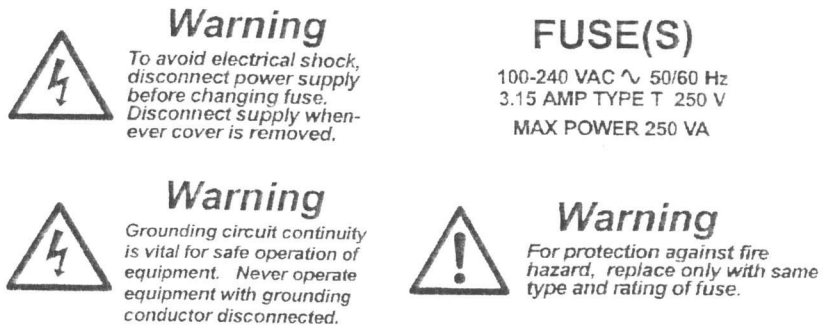

Figure 2 Warning labels on the rear of the instrument

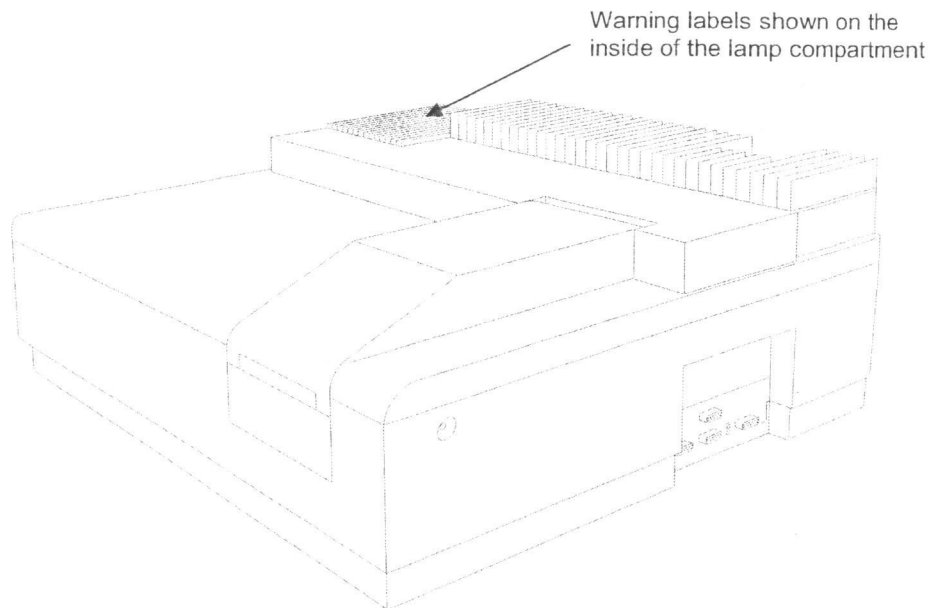

Figure 3 Lambda 25, 35, 45 Spectrometers warning labels (inside of lamp compartment)

The following warnings are shown on the inside of the lamp compartment.



**Warning**  
*To avoid electrical shock,  
disconnect power cord before servicing*



**Warning**  
*Hot Lamp*



**Warning**  
*UV Light Source*  
*Wear Protective Glasses*  
*When Working With Lid Open*

Figure 4 Warnings on the inside of the lamp compartment

*Introduction* **2**

---

## About this Manual

---

This manual contains the following sections:

- *Warnings and Safety Information* starting on page 7 and describes operating conditions of the instrument, electrical safety requirements, how to lift the instrument safely and the description and location of various warning labels that are placed on the instrument. Various regulatory and compliance requirements, met or exempt, are also covered here.
- *Introduction* starting on page 21, covers the conventions that are used in this manual.
- *System Description* starting on page 35, provides an overview of the Lambda 25/35/45 series of instruments. Additionally, the optical system and technical specifications of the instruments are also discussed.
- *Installation* starting on page 45, covers the installation of the instrument, computer, software and single cell holder and the preparation required to undertake these.
- *Accessories* starting on page 67, describes how accessories are connected to the instrument and the type of accessories that are generally available.
- *Maintenance* starting on page 81, describes how to replace, repair and maintain various replacement parts of the instrument. The cleaning of the sample compartment and the use and care of cells is also covered.
- *Analytical Notes* starting on page 99 provides information on samples that are not covered by the Beer-Lambert Law and considerations required for volatile, chemically reactive samples etc.

## ***Conventions Used in this Manual***

---

Normal text is used to provide information and instructions.

**Bold** text refers to text that is displayed on the screen.

UPPERCASE text, for example ENTER or ALT, refers to keys on the PC keyboard. '+' is used to show that you have to press two keys at the same time, for example, ALT + F.

### ***Definitions***

**Responsible body:** individual or group responsible for the use and maintenance of equipment, and for ensuring that operators are adequately trained.

**Operator:** person operating equipment for its intended purpose.

### ***Notes, cautions and warnings***

Three terms in the following standard formats, are also used to highlight special circumstances and warnings.

**NOTE:** *A note indicates additional, significant information that is provided with some procedures.*

**CAUTION**

We use the term **CAUTION** to inform you about situations that could result in **serious damage to the instrument** or other equipment. Details about these circumstances are in a box like this one.

**D****Caution (Achtung)**

Bedeutet, daß die genannte Anleitung genau befolgt werden muß, um einen **Geräteschaden** zu vermeiden.

**DK****Caution (Bemærk)**

Dette betyder, at den nævnte vejledning skal overholdes nøje for at undgå en **beskadigelse af apparatet**.

**E****Caution (Advertencia)**

Utilizamos el término **CAUTION (ADVERTENCIA)** para advertir sobre situaciones que pueden provocar **averías graves en este equipo** o en otros. En recuadros éste se proporciona información sobre este tipo de circunstancias.

**F****Caution (Attention)**

Nous utilisons le terme **CAUTION (ATTENTION)** pour signaler les situations susceptibles de provoquer de **graves détériorations de l'instrument** ou d'autre matériel. Les détails sur ces circonstances figurent dans un encadré semblable à celui-ci.

**I****Caution (Attenzione)**

Con il termine **CAUTION (ATTENZIONE)** vengono segnalate situazioni che potrebbero arrecare **gravi danni allo strumento** o ad altra apparecchiatura. Troverete informazioni su tali circostanze in un riquadro come questo.

**NL****Caution (Opgelet)**

Betekent dat de genoemde handleiding nauwkeurig moet worden opgevolgd, om **beschadiging van het instrument** te voorkomen.

**P****Caution (Atenção)**

Significa que a instrução referida tem de ser respeitada para evitar a **danificação do aparelho**.



**WARNING**

We use the term **WARNING** to inform you about situations that could result in **personal injury** to yourself or other persons. Details about these circumstances are in a box like this one.

**D**

**Warning (Warnung)**

Bedeutet, daß es bei Nichtbeachten der genannten Anweisung zu einer **Verletzung** des Benutzers kommen kann.

**DK**

**Warning (Advarsel)**

Betyder, at brugeren kan blive **kvæstet**, hvis anvisningen ikke overholdes.

**E**

**Warning (Peligro)**

Utilizamos el término **WARNING (PELIGRO)** para informarle sobre situaciones que pueden provocar **daños personales** a usted o a otras personas. En los recuadros como éste se proporciona información sobre este tipo de circunstancias.

**F**

**Warning (Danger)**

Nous utilisons la formule **WARNING (DANGER)** pour avertir des situations pouvant occasionner des **dommages corporels** à l'utilisateur ou à d'autres personnes. Les détails sur ces circonstances sont données dans un encadré semblable à celui-ci.

**I**

**Warning (Pericolo)**

Con il termine **WARNING (PERICOLO)** vengono segnalate situazioni che potrebbero provocare **incidenti alle persone**. Troverete informazioni su tali circostanze in un riquadro come questo.

**NL**

**Warning (Waarschuwing)**

Betekent dat, wanneer de genoemde aanwijzing niet in acht wordt genomen, dit kan leiden tot **verwondingen** van de gebruiker.

**P**

**Warning (Aviso)**

Significa que a não observância da instrução referida poderá causar um **ferimento** ao usuário.

## Other Warnings used in this Manual



WARNING

### Unauthorized Adjustments and Servicing

W01.02

Do not attempt to make adjustments, replacements or repairs to this instrument except as described in the accompanying User Documentation. Only a PerkinElmer service representative or similarly trained and authorized person should be permitted to service the instrument.

D

### Unzulässige Arbeiten am Gerät

Wartungs- oder Reparaturarbeiten oder Justierungen, die in der Benutzerdokumentation zum Gerät *nicht* beschrieben sind, dürfen nur vom PerkinElmer Kundendienst oder von entsprechend ausgebildeten und autorisierten Fachkräften ausgeführt werden.

DK

### Ikke-tilladte arbejder på apparatet

Vedligeholdelses- eller reparationsarbejder eller justeringer, som *ikke* er beskrevet i dokumenterne til brugeren, må kun udføres af PerkinElmers kundeservice eller af tilsvarende uddannede og autoriserede folk.

E

### Ajustes y servicios sin autorización

No intente realizar ningún tipo de ajuste, sustitución o reparación en este aparato, a excepción de lo descrito en la Documentación del Usuario que se adjunta. Tan sólo un ingeniero de Servicio Técnico de PerkinElmer o una persona de formación y autorización similares podrán realizar trabajos de revisión y mantenimiento del instrumento.

F

### Réglages et entretien non autorisés

Ne pas essayer d'effectuer des réglages, des remplacements ou des réparations sur cet instrument d'une manière autre que celle décrite dans la Documentation Utilisateur jointe. Seul un représentant du service après-vente PerkinElmer ou une personne autorisée et de même formation devraient être autorisés à intervenir sur l'instrument.

I

### Regolazione e manutenzione non autorizzate

Non tentare di regolare, sostituire o riparare questo strumento se non come descritto nell'allegata Documentazione Utente. Solo un rappresentante dell'assistenza PerkinElmer o una persona dalla analoga esperienza può eseguire, se autorizzata, la manutenzione dello strumento.

NL

### Niet toegestane werkzaamheden aan het instrument

Onderhouds-, reparatie- of afstelwerkzaamheden die *niet* in de gebruikersdocumentatie van het instrument worden omschreven, mogen alleen door personeel van de klantenservice of door overeenkomstig geschoolde en geautoriseerde vakmensen worden uitgevoerd.

P

### Trabalhos não permitidos no aparelho

Trabalhos de manutenção ou de reparação ou ajustamentos *não* descritos na documentação do usuário para o aparelho apenas podem ser executados pelo Serviço Técnico da PerkinElmer ou por pessoal especializado devidamente formado e autorizado.





WARNING

**Explosive Atmosphere**

*This instrument is not designed for operation in an explosive atmosphere.*

**D**

**Explosionsfähige Atmosphären**

*Das Gerät darf nicht in explosionsfähigen Atmosphären betrieben werden!*

**DK**

**Eksplorative omgivelser**

*Apparatet må ikke anvendes i eksplorative omgivelser!*

**E**

**Atmósfera explosiva**

*Este aparato no ha sido diseñado para utilizarlo en atmósferas explosivas.*

**F**

**Atmosphère explosive**

*Cet instrument n'est pas conçu pour fonctionner dans une atmosphère explosive.*

**I**

**Atmosfera esplosiva**

*Questo strumento non è adatto per l'uso in atmosfera esplosiva.*

**NL**

**Explosiegevaarlijke omgevingen**

*Het instrument mag niet in een explosiegevaarlijke omgeving worden gebruikt!*

**P**

**Atmosferas explosivas**

*O aparelho não pode ser utilizado em atmosferas explosivas!*



WARNING

**Electrical Hazard**

Any interruption of the protective conductor inside or outside the instrument or disconnection of the protective conductor (earth/ground) terminal is likely to make the instrument dangerous. Intentional interruption is prohibited.

D

**Gefährdung durch Elektrizität**

Das Gerät muß zum Betrieb immer geerdet sein. Auf keinen Fall die Schutzleiter im Gerät oder in der Netzleitung trennen oder entfernen.

DK

**Fare på grund af elektricitet**

Apparatet skal altid være jordet. Man må under ingen omstændigheder skille eller fjerne jordlederen inde i apparatet eller i strømledningen.

E

**Peligro eléctrico**

Cualquier interrupción del conductor de protección dentro o fuera del aparato, o la desconexión del terminal del mismo (toma de tierra) podrían ocasionar serios peligros al usar el equipo. Prohibida la interrupción intencionada.

F

**Risque d'électrocution**

Toute interruption du conducteur de protection à l'intérieur ou à l'extérieur de l'instrument, ou déconnexion du raccord du conducteur de protection (terre) peut rendre l'instrument dangereux. Il est interdit d'interrompre volontairement ce conducteur.

I

**Pericolo: elettricità**

Qualsiasi interruzione della protezione del conduttore all'interno o all'esterno dello strumento, o lo scollegamento del terminale (di terra/massa) del conduttore di protezione possono rendere pericoloso lo strumento. È vietato provocare volontariamente queste interruzioni.

NL

**Risico's door elektriciteit**

Het instrument moet voor de werking altijd geaard zijn. In geen geval mag de aarding van het instrument of de netvoeding worden onderbroken of worden verwijderd.

P

**Perigo por electricidade**

Para a operação o aparelho tem de estar sempre ligado à terra. De forma alguma separar ou retirar os condutores de protecção à terra no aparelho ou no cabo de alimentação da rede.



WARNING

**Lethal voltages are present in the instrument**

- Even with the power switch OFF, line power voltages can still be present within the instrument.
- When the instrument is connected to line power, terminals may be live, and opening covers or removing parts (except those to which access can be gained by hand) is likely to expose live parts.
- Capacitors inside the instrument may still be charged even if the instrument has been disconnected from all voltage sources.

D

**Gefährliche Spannung im Gerät**

- Auch in ausgeschaltetem Zustand kann an einigen Stellen im Gerät Netzspannung anliegen, wenn das Gerät am Stromnetz angeschlossen ist.
- Auch bei ausgeschaltetem Gerät und getrennter Netzverbindung können Kondensatoren im Gerät noch mit gefährlicher Spannung geladen sein.

DK

**Farlig spænding i apparatet – fare for kvæstelser**

- Også i slukket tilstand kan der være netspænding nogle steder i apparatet, hvis apparatet er tilsluttet til strømmettet.
- Selv når apparatet er slukket, og strømforbindelsen er afbrudt, kan kondensatorene i apparatet være ladet med farlig spænding.

E

**En el aparato existen voltajes letales**

- Incluso con el interruptor desconectado, puede haber voltaje dentro del equipo.
- Cuando el instrumento se encuentre conectado a la red eléctrica, los terminales pueden estar bajo corriente y éstos quedar expuestos al abrir las cubiertas o al extraer componentes (exceptuando aquellos a los cuales se puede acceder con la mano).
- Los condensadores internos del aparato pueden permanecer cargados incluso cuando el aparato haya sido desconectado del voltaje de la línea.

F

**Présence de tensions mortelles dans l'instrument**

- Même lorsque l'interrupteur de puissance est sur ARRET, des tensions de secteur peuvent encore être présentes dans l'instrument.
- Lorsque l'instrument est relié au secteur, les raccords peuvent être sous tension, et des parties sous tension peuvent être découvertes en ouvrant des capots ou en retirant des pièces (à l'exception de celles auxquelles il est possible d'accéder manuellement).
- Les condensateurs contenus dans l'instrument peuvent encore être chargés, même si l'instrument a été déconnecté de toutes les sources de tension.



WARNING

**Lethal voltages are present in the instrument**

- Even with the power switch OFF, line power voltages can still be present within the instrument.
- When the instrument is connected to line power, terminals may be live, and opening covers or removing parts (except those to which access can be gained by hand) is likely to expose live parts.
- Capacitors inside the instrument may still be charged even if the instrument has been disconnected from all voltage sources.

I

**Nello strumento sono presenti tensioni mortali**

- Anche se l'interruttore di alimentazione è in posizione OFF, la tensione di linea può essere ancora presente all'interno dello strumento.
- Quando lo strumento è collegato alla rete di alimentazione i terminali possono essere sotto tensione; aprendo le calotte di protezione o rimuovendo alcune parti (ad eccezione di quelle raggiungibili con la mano) è possibile esporre altre parti sotto tensione.
- Anche se lo strumento è stato scollegato da tutte le fonti di tensione, i condensatori al suo interno possono essere ancora carichi.

NL

**Gevaarlijke spanningen in het instrument – gevaar van letsel**

- Ook in uitgeschakelde toestand kan, wanneer het instrument op de netvoeding is aangesloten, op sommige plaatsen in het instrument netspanning staan.
- Ook bij een uitgeschakeld instrument en een onderbroken netvoeding kunnen condensatoren in het instrument nog een gevaarlijke lading bevatten.

P

**Tensão perigosa no aparelho – perigo de ferimento**

- Mesmo desligado, o aparelho poderá ainda ter tensão de rede em alguns pontos enquanto estiver ligado à rede de corrente.
- Mesmo com o aparelho desligado e a ligação à rede de corrente interrompida, os condensadores dentro do aparelho ainda poderão ter uma tensão perigosa aplicada.



**Electrical Hazard**

To prevent potential injury to yourself and damage to the instrument, switch OFF all instruments in the system and disconnect them from the line power supply before you alter, or make any new, electrical connections.



**Gefährdung durch Elektrizität**

Um Verletzungsgefahr durch elektrische Spannung und Beschädigungsgefahr der Geräte zu vermeiden, schalten Sie alle Geräte des Meßplatzes AUS und trennen Sie die Netzverbindungen, bevor Sie irgendwelche elektrischen Verbindungen herstellen oder ändern.



**Fare på grund af elektricitet**

For at undgå faren for kvæstelser fra den elektriske spænding og faren for beskadigelse af apparaterne, skal alle apparater på målepladsen være SLUKKET, og strømforbindelserne skal være skilt, inden De opretter eller ændrer noget i de elektriske forbindelser.



**Peligro eléctrico**

Para evitar posibles daños personales y al equipo, apague todos los módulos del sistema y desconéctelos de la toma de corriente antes de establecer nuevas conexiones eléctricas, o de modificar conexiones existentes.



**Risque d'électrocution**

Afin d'éviter des blessures éventuelles et des détériorations de l'instrument, mettre tous les instruments du système hors tension et les déconnecter de l'alimentation par le secteur avant de modifier des connexions électriques ou d'en réaliser de nouvelles.



**Pericolo: elettricità**

Per evitare potenziali incidenti alle persone e danni allo strumento mettere in posizione OFF l'interruttore di tutti gli strumenti del sistema e scollegarli dalla fonte di alimentazione prima di modificare i collegamenti elettrici o di creare nuovi collegamenti.



**Risico's door elektriciteit**

Om het gevaar van letsel door elektrische spanning en het gevaar voor beschadiging van het instrument te voorkomen, schakelt u, voordat u welke elektrische verbinding dan ook wilt maken of wilt veranderen, alle instrumenten van de meetplaats UIT en ontkoppelt u de netvoeding.



**Perigo por electricidade**

A fim de evitar o perigo de ferimento por tensão eléctrica e o perigo de danificação dos aparelhos, DESLIGUE todos os aparelhos do posto de medição e interrompa as ligações à rede antes de estabelecer ou modificar qualquer ligação eléctrica.



WARNING

**UV Radiation – Risk of Eye Damage**

The lamp emits intense UV radiation which can damage your eyes.

Do not gaze into a lighted lamp.

Always wear UV absorbing safety glasses when looking at the radiation from the lamp.

D

**UV-Strahlung – Gefährdung der Augen**

Die Strahlungsquelle/Lampe emittiert intensive UV-Strahlung und kann dadurch Augenschäden verursachen.

Tragen Sie eine Schutzbrille, die die emittierte UV-Strahlung ausreichend absorbiert, wenn Sie in die leuchtende Strahlungsquelle/Lampe schauen.

DK

**Ultraviolet stråling – farligt for øjnene**

Strålingskilden/lampen emitterer ultraviolet stråling og kan derfor forårsage øjenskader.

Bær beskyttelsesbriller, som absorberer den emitterede ultraviolette stråling tilstrækkeligt, når De ser ind i den lysende strålingskilde.

E

**Radiación de rayos ultravioleta**

La lámpara emite una intensa radiación de rayos ultravioleta, que puede ser perjudicial para los ojos. No mire fijamente a la lámpara.

Al examinar la radiación de las lámparas, utilice siempre gafas de seguridad que absorban este tipo de rayos.

F

**Rayonnement UV**

La lampe émet un rayonnement UV intense susceptible de provoquer des lésions oculaires. Ne pas regarder fixement une lampe allumée.

Toujours porter des lunettes de protection absorbant les UV pour regarder le rayonnement des lampes.

I

**Radiazioni ultraviolette**

La lampada emette intense radiazioni ultraviolette dannose per gli occhi. Non fissare le lampade accese.

Indossare sempre occhiali protettivi ad assorbimento degli ultra-violetti quando si guardano le radiazioni emesse dalla lampade.

NL

**UV-straling – Risico's voor de ogen**

De stralingsbron/lamp emitteert intensieve UV-straling en kan daardoor letsel aan de ogen veroorzaken.

Draag een veiligheidsbril, die de geëmitteerde UV-straling voldoende absorbeert, wanneer u in de brandende stralingsbron moet kijken.

P

**Radiação UV – perigo para os olhos**

A fonte de radiação/lâmpada emite uma radiação UV intensa podendo assim provocar ferimentos aos olhos.

Use óculos de protecção que absorvam suficientemente a radiação UV emitida ao olhar directamente para a fonte de radiação luminosa.

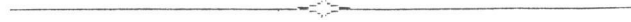

*System Description* **3**

---



## **Introduction**

---

### **Instruments**

The Lambda 25, 35, 45 are versatile spectrometers operating in the ultraviolet (UV) and visible (Vis) spectral ranges. All Lambda instruments are easy to operate and have the following features:-

- True double-beam operation provides the best possible stability and allows references to be measured and corrected in real-time.
- Sealed and quartz coated high throughput optics ensure consistently high performance throughout the instrument's service life.
- Fast Scanning with no compromise in analytical performance.
- Surpasses all regulatory body, quality system and pharmacopoeia requirements.
- Pre-aligned deuterium and tungsten halogen lamps mean that when a lamp needs to be replaced there's no service call and no down-time.

### **UV WinLab Software**

The Lambda instruments are controlled via UV WinLab software which has an intuitive workflow user-interface which assists and guides the user through method development, reporting and analysis of results in a series of simple steps. With the powerful access control, users may be given access to only the features and options within the software that they need. All results that are obtained from sample analysis are stored in a secure, encrypted relational database, and can be readily retrieved for further analysis (trending) or to simply review past results.

## Major Components

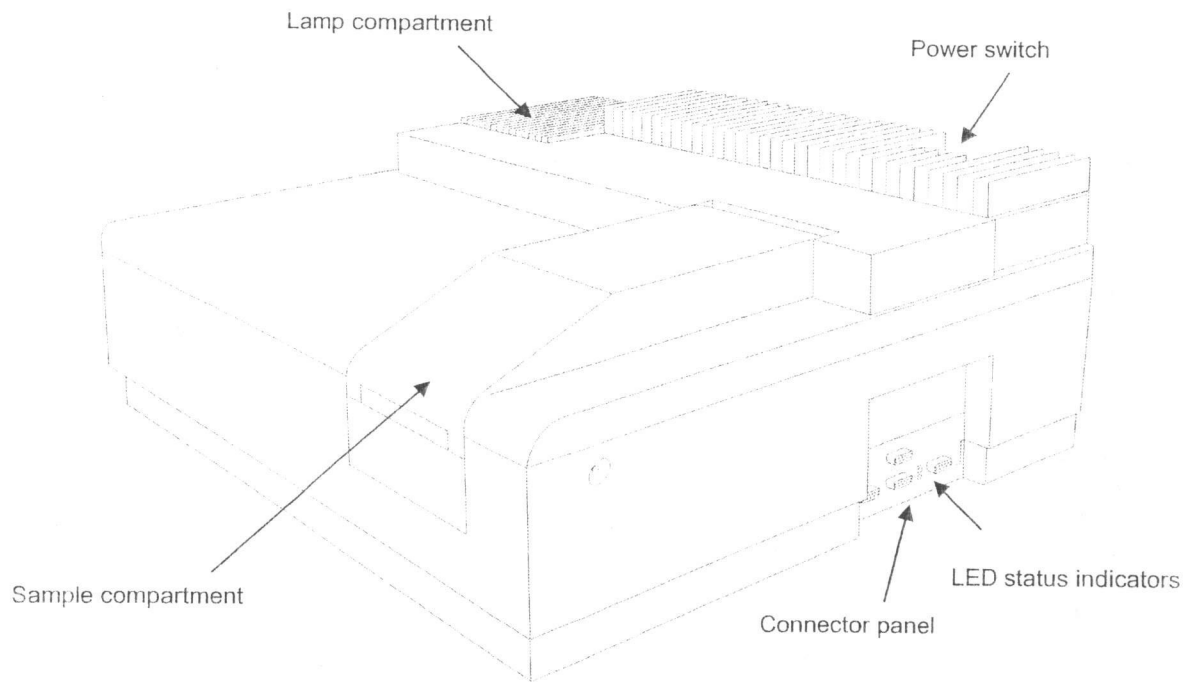

Figure 5 Lambda 25, 35, 45 Spectrometer Features

## Optical System of the Lambda 25, 35, 45

The Lambda 25, 35, 45 UV/Vis Spectrometers features an all-reflecting optical system. The optical components are coated with silica for durability. A holographic grating is used in the monochromator.

The optical system is depicted schematically in Figure 6.

The monochromator is a holographic concave grating with 1053 lines/mm in the center.

Two radiation sources, a deuterium lamp and a tungsten halogen lamp, cover the working wavelength range of the spectrometer.

For operation in the visible (Vis) range, mirror M1 reflects the radiation from the halogen lamp onto source mirror M2. At the same time M1 blocks the radiation from the deuterium lamp.

**NOTE:** *In the Lambda 45, M2 is substituted by a pre-monochromator grating, increasing the straylight performance of the instrument.*

For operation in the ultraviolet (UV) range, mirror M1 is raised to permit radiation from the deuterium lamp to strike source mirror M2.

Source change is automatic during monochromator slewing.

Radiation from the source lamp is reflected from source mirror M2 through an optical filter on the filter wheel assembly.

A stepping motor drives the filter wheel to be in synchronization with the monochromator.

Depending on the wavelength being produced, the appropriate optical filter is located in the beam path to prefilter the radiation before it enters the monochromator.

Filter change is automatic during monochromator slewing.

From the optical filter the radiation passes through the entrance slit (Slit 1) of the monochromator grating.

The radiation is dispersed at the grating to produce a spectrum. The rotational position of the grating effectively selects a segment of the spectrum, reflecting this segment through the exit slit (Slit 2) to mirror M3.

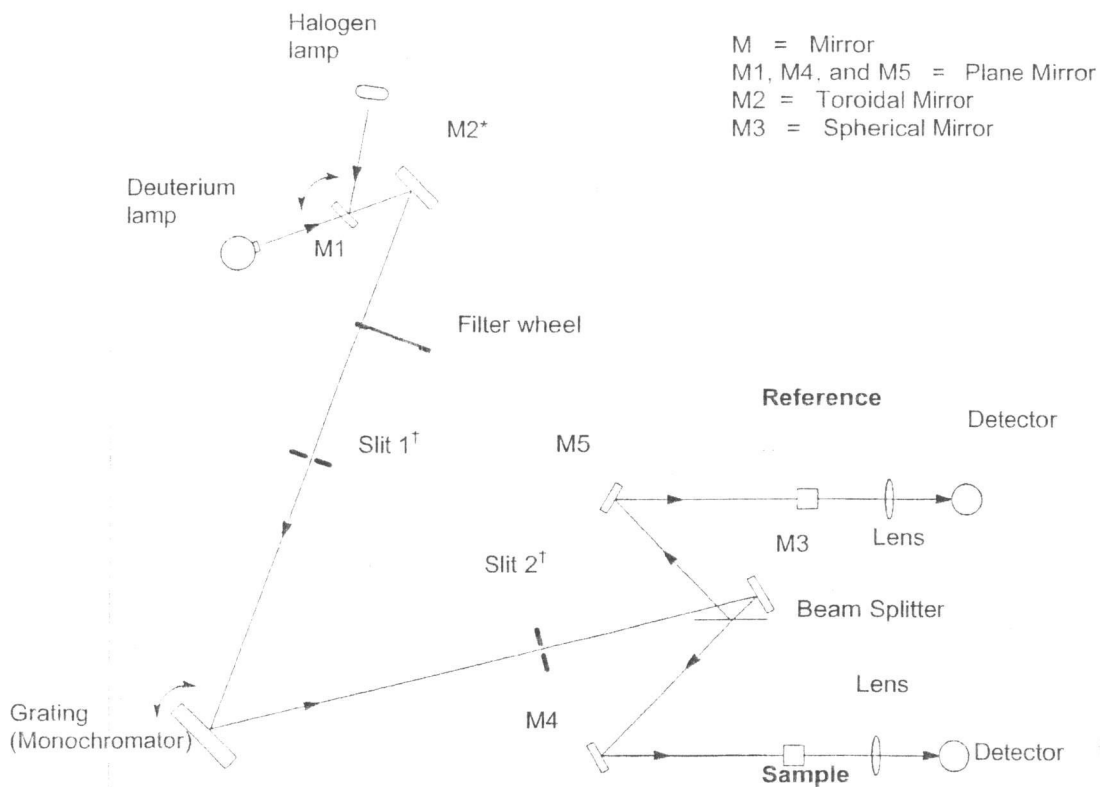

Figure 6 Optical Path for Lambda 25, 35, 45

\* replaced with a pre-monochromator in the Lambda 45

† - selectable on the Lambda 35/45

The exit slit restricts the spectrum segment to a near-monochromatic radiation beam.

The slits provide a spectral bandpass of 1 nm on the Lambda 25, and the spectral bandpasses are selectable to be 0.5, 1, 2, or 4 nm on the Lambda 35 or 45.

From mirror M3 the radiation is reflected onto a beam splitter which allows 50% of the radiation to pass onto plane mirror M4, and reflects 50% of the radiation onto plane mirror M5.

Mirror M4 focuses the radiation beam in the sample cell.

The beam then passes through a convex lens onto the photodiode detector.

Mirror M5 focuses the radiation beam in the reference cell.

The beam then passes through a convex lens onto the photodiode detector.

## **Lambda 25, 35 and 45 Specifications**

### **General**

Type	Scanning double-beam spectrometer for the UV/Vis range; operation by PC
Dimensions	Width: 650 cm Height: 260 cm Depth: 560 cm
Mass	26 kg approx.
Power requirements	100 V to 240 V AC, 50/60 Hz; 250 VA
Ambient operating temperature	15 °C to 35 °C
Humidity range	20% to 80% relative humidity without condensation
Technical Standard	In compliance with the requirements for technical instruments stipulated by IEC 61010-1:1990 and amendments A1:1992 and A2:1995.
Radio interference suppression	In compliance with the legal requirements of the EMC directive 89.336/EEC (EN 61326)

**Optics**

Beam center height		15 mm above cell holder bottom
Beam cross-section	Lambda 25	1 nm slit ca. 0.6 mm x 9 mm (width x height) at focal point of sample and reference beam in sample compartment
	Lambda 35 and Lambda 45	0.5 nm slit ca. 0.25 mm x 7 mm (width x height) 1 nm slit ca. 0.5 mm x 7.5 mm (width x height) 2 nm slit ca. 1 mm x 7.5 mm (width x height) 4 nm slit ca 2 mm x 7.5 mm (width x height), at focal point of sample and reference beam in sample compartment
Optical pathlength in sample compartment		121 mm
Grating (Monochromator)		Holographic concave grating with 1053 lines/mm in the center
Radiation sources		Pre-aligned deuterium and halogen lamps
Detector		Photodiodes (One for the sample beam and one for the reference beam)

**Data Output**

Digital port	One RS 232 C interface (serial), for connecting a PC.
--------------	---





*Installation* **4**

---

## ***Installation Summary***

---

We recommend that you read the entire chapter regarding installation, before commencing with the installation itself. This then allows you to make a note of any pertinent factors that are of particular importance to your environment.

PerkinElmer provide an installation service, should you require it, however the instrument is quick and easy to install and can be performed by following the instructions laid out in this Chapter.

For a standard system, that is not a ES (Enhanced Security) system, you may want to read the Quick Install Guide that is supplied.

The UV WinLab online Help and Tutorials may also provide suitable information, on completion of the installation of the software and instrument.

The installation of the system is divided into the following steps:

- Preparing the work area;
- Unpacking the instrument;
- Equipment provided;
- Installing the Instrument and the PC;
- Startup and Shutdown;
- Installing and aligning the Single Cell Holder.

## **Preparing the Laboratory**

---

For maximum stability and minimum maintenance, the laboratory in which the Lambda instrument is located must meet the following conditions:

- The instrument will operate with a laboratory temperature between 15 and 35 °C (59- 95 °F). For optimum instrument performance, the room temperature should be controlled at  $20^{\circ} \pm 2^{\circ} \text{C}$ .
- Enough space around and underneath the instrument for efficient air circulation.
- Constant humidity between 20% and 80% relative humidity.
- A firm base, free of excessive vibration.
- An atmosphere free from dust and corrosive fumes.
- Keep out of direct sunlight.
- A compatible source of electrical power should be located in the vicinity of the instrument.  
Electrical power must be available at a proper earth-grounded 3-wire electrical outlet.
- The standard sample compartment baseplates have drain holes in them to run off spilled liquids to the benchtop underneath the instrument. If required, a sheet of thick filter paper can be placed under the instrument.
- The Lambda instrument has been designed for indoor use. Do not use the instrument in an area where explosion hazards may exist as the instrument contains lamps, which do get hot.

## Laboratory Space Requirements

### Instrument Dimensions

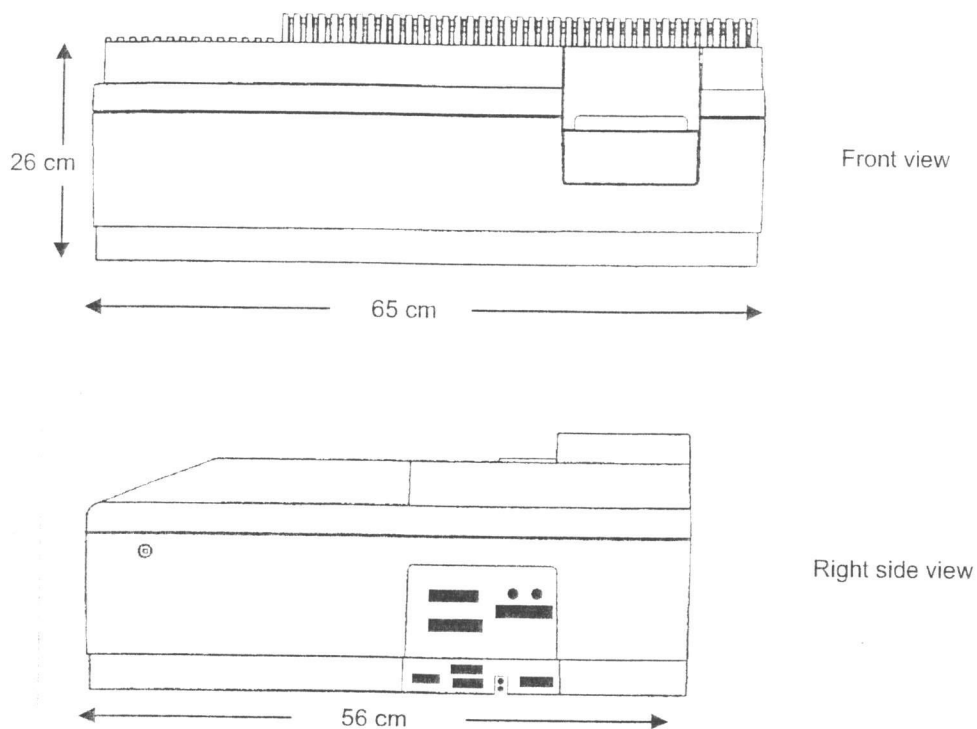

Figure 7 Space Requirements

**NOTE:** Remember to leave sufficient space on the right-hand side for the PC. Additionally also ensure that there is sufficient space above the instrument so that samples may be readily placed and removed from the instrument and that the lamp compartment cover can be accessed.

Dimensions of the Instrument

	<b>Width</b>	<b>Depth</b>	<b>Height</b>	<b>Weight</b>
<b>Lambda 25 / Lambda 35 / Lambda 45</b>	65 cm (25.6 in)	56 cm (22.0 in)	26 cm (10.2 in)	26 kg (57.2 lb)

Dimensions of the PC provided by PerkinElmer (if ordered):

	<b>Width</b>	<b>Depth</b>	<b>Height</b>	<b>Weight</b>
<b>Base unit (mini tower)</b>	18.1 cm (7.13 in)	44.7 cm (17.61 in)	42.5 cm (16.75 in)	12.72 kg (28 lb)
<b>Monitor (15 inch)</b>	39.8 cm (15.7 in)	43 cm (16.9 in)	41.7 cm (16.4 in)	17.6 kg (38.8 lb)

## ***Unpacking your Instrument***

---

### ***Unpacking and Inspection***

- Unpack the components carefully.
- Keep the packing materials for possible future storage or reshipment.
- Examine the components for any signs of damage in shipment.
- Check the entire outer casing of the spectrometer for damage.
- Make sure that terminals, fuse holders, etc. are not damaged.
- Open and close the sample compartment cover, checking that it moves freely without binding.
- The sample compartment must be free of dust or other foreign matter.

In the event of damage or missing parts, file an immediate claim with the authorized carrier, and inform your PerkinElmer office or representative.

## ***Equipment Provided***

---

The shipping containers will contain your Lambda 25, 35 or 45 instrument plus any additional accessories you have ordered.

<b>Quantity</b>	<b>Item</b>	<b>Part Number</b>
2	Single-cell holders	B0505071
1	Screwdriver 4 mm	B0126972
1	Hexagonal socket-head wrench 3 mm	B0140883
10	Spare fuses	B0155573
1	Line power cord with suitable connector for electrical outlets	varies
1	Lambda 25, 35, 45 User's Guide	09934586
1	9 pin RS232 cable	09410022
1	UV WinLab software kit (ES or Standard)	varies

## Installing the Instrument and the PC

### **Connecting the PC to the spectrometer**

- Connect all electrical supplies from the computer and monitor and connect the PC COM port (usually marked **10101**) to the connector on the right hand side of the spectrometer as shown in Figure 8.

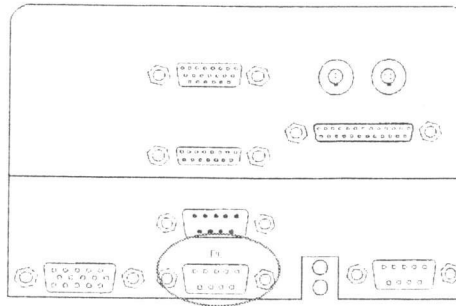

Figure 8 Connecting the PC to the spectrometer



## Connecting the Instrument to the Power Supply



### **Electrical Hazard**

*To prevent potential injury to yourself and damage to the instrument, first make the electrical connections between the instruments in the system before connecting to the line power supply.*

*The spectrometer automatically adjusts to the correct operating voltage. Before starting the instrument for the first time, make sure that the correct fuse is fitted to your line power supply. If you have a different fuse, change it for the correct one. Do not connect the spectrometer to the line power supply if the wrong fuse is fitted.*

**NOTE:** *To prevent interferences caused by earth loops when operating with ancillary instruments (autosamplers, etc.), connect all components of the system to the same phase of the electrical supply via a multisocket distributor.*

**NOTE:** *Do not replace the instrument power plug.*

**NOTE:** *PerkinElmer instruments will normally operate within a 10% range of the specified voltage and within 1 Hz of the specified frequency, unless otherwise noted. If the power line is unstable, fluctuates in frequency or is subject to surges, additional control of the incoming power may be required.*

1. Make sure that the plug fitted to the line power cord provided with the spectrometer is suitable for your local electrical outlets.
2. After all connections have been made between the various components of the system, make certain that all power switches are set to OFF, then connect the line cords to the electrical power supply.

The power switch is located at the top right-hand rear of the spectrometer.

## **Startup and Shutdown**

**NOTE:** *If you have purchased accessories you may want to install these first, before commencing with the Startup procedure. An overview of accessories is available on page 67.*

**NOTE:** *We recommend that for optimal performance of the instrument you should leave the spectrometer switched on for approximately one hour to allow the lamps to warm up and stabilize before starting analysis. After warm-up, re-initialize the calibration sequence by toggling the power switch off, wait a moment and then toggle the power switch on. Wait until all initialization is complete before starting UV WinLab. This will take approximately three minutes from switching the power on.*

### **Startup**

1. Open the sample compartment cover.
2. Make sure that the beam paths are free, that is,
  - No objects (for example, cables) project into the beam paths.
  - No samples are in the sample compartment.
  - Accessories are properly installed.

**NOTE:** *If the sample compartment is obstructed during the startup procedure, the spectrometer will not initialize correctly.*

3. Close the sample compartment cover.
4. Switch on the power switch (which is located at the top right hand corner of the instrument).
  - a) The lower LED will light up. This indicates power to the instrument.
  - b) The upper LED will light up. This indicates that the instrument is idle and on stand by.
5. Switch on any accessories.

**NOTE:** *We recommend that before starting analysis that you leave the spectrometer switched on for approximately 10 minutes to allow the lamps to warm up and stabilize.*

### **Installing UV WinLab version 4.0 or higher**

Ensure that the instrument is switched on for at least 3 minutes before attempting to install the software so that the instrument can initialise.

#### **UV WinLab Standard**

To install the Standard version of UV WinLab, refer to the instructions provided on the front cover of the UV WinLab software CD.

#### **UV WinLab Enhanced Security**

To install the Enhanced Security version of UV WinLab, refer to the Installation section of the Administrator's Guide.

### **Starting UV WinLab**

UV-VIS

1. Select  UV WinLab, on the start menu under Programs, then PerkinElmer Applications, then UV WinLab.  
The Login dialog is displayed.
2. Enter the User name and Password.  
The default User name is Analyst and the Password is analyst.

**NOTE:** *If you are using the Enhanced Security version of UV WinLab, you will have to change your password the first time you log in. If you are using the Standard version of UV WinLab, we recommend that you change the default Password as soon as possible after logging in.*

3. Click **OK**.

The Login dialog closes and UV WinLab Explorer is displayed

For further information on how to use the software see the on-screen Help or the Tutorials by selecting **Contents and Index** or **Tutorials** from the Help menu within the Explorer.

A printable pdf version of the Help file is available from a Toolbar button in the Help.

**NOTE:** *Before UV WinLab can be used to control the instrument, the instrument must be added to the list of Instruments within the software. Refer to the online Help and Tutorial for guidance.*

### **Shutdown**

1. Close down UV WinLab.
2. Switch off any externally powered accessories.
3. Open the sample compartment cover.
4. Remove samples and cells from the sample compartment.
5. If accessories (for example, flowcell) are installed in the sample compartment clean them thoroughly.
6. Close the sample compartment cover.
7. Switch off the spectrometer.

## Installing the Single Cell Holder

The instrument is shipped with the Single Cell Holder already installed. However, the installation of the Single Cell Holder is included here, in case the holder had to be removed to accommodate an accessory and needs to be placed back in the instrument after the accessory has been used.

### **Description**

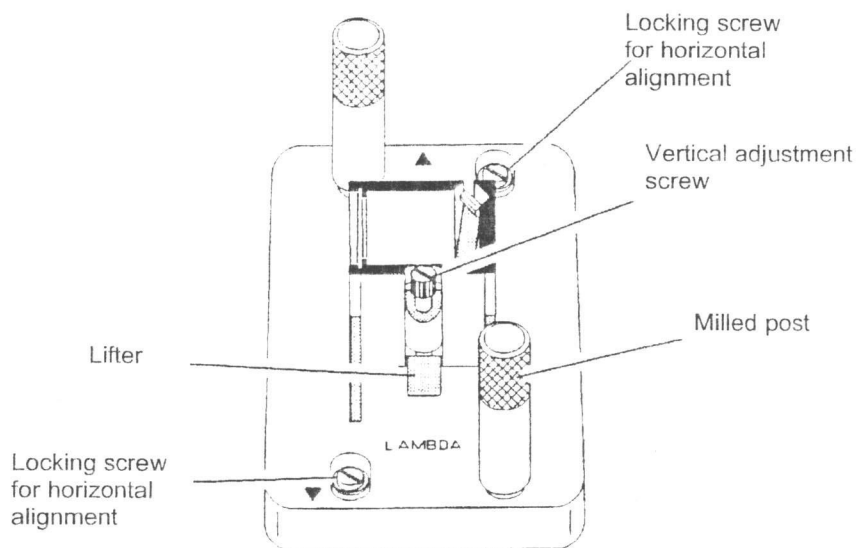

**Figure 9 Single Cell Holder B0505071**

The single cell holder can be installed in two different positions in the sample compartment, in line with the inscriptions as referenced below. This is to ensure optimal performance when using different cell types.

Inscription on Holder	Use in Spectrometer
LAMBDA	In this position, the cell holder can be used with all Lambda Series Spectrometers.
BIO LAMBDA 2	The cell holder should be used in this position with Lambda 25, 35, 45 Series Spectrometers. The smallest beam diameter is exactly in the middle of the cell. This is useful especially for operation with micro and semi-micro cells.

### ***Installing the Cell Holder***

**NOTE:** *Always install the holder such that the arrow on the cell holder lines up with the center point on the baseplate.*

Install the single cell holder in the sample compartment as follows:

1. Orientate the holder so that the lifter is toward the rear of the sample compartment.
2. Lower the holder so that the two alignment holes slip onto the two studs on the baseplate at the bottom of the sample compartment.
3. The arrow on the cell holder must line up with the center point of the baseplate.

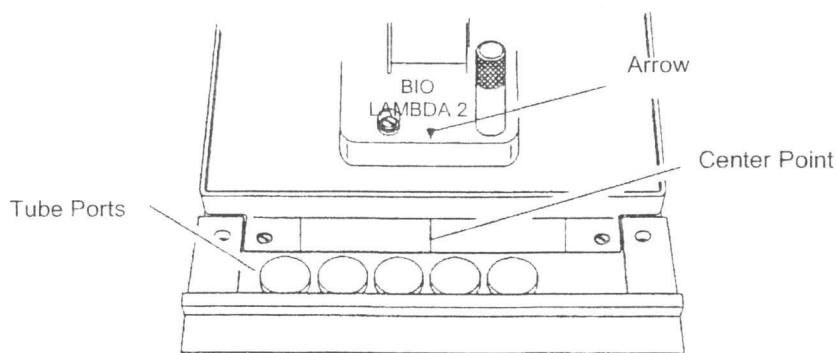

**Figure 10 Installing the single cell holder**

4. Move the milled posts a little to locate the threaded holes in the baseplate, and then tighten the milled posts.  
The tube ports located at the front of the sample compartment allow you to lead tubes from flowcells, water-thermostatted cell holders, etc. in and out of the sample compartment.  
When not in use, you should always insert the caps into the ports.

### ***Aligning the Single Cell Holder***

Coarse alignment of the single cell holder is carried out as follows:

1. Start the system as described in Startup on page 55.
2. Open the sample compartment cover.
3. Fill cells of the same composition with a low-absorbing solvent (deionized water or ethanol).
4. Insert one cell into the sample cell holder and one into the reference cell holder.  
Make certain that the cell is pushed down fully.

**NOTE:** *The alignment procedure is for a given cell in a given holder. After alignment, the cell should always be used in the same holder.*

5. Block the sample and reference beam window on the right hand side of the sample compartment with a card to prevent white light from saturating the detector.
6. Return to standby display.
7. From the Tools menu in UV WinLab Explorer select **Manual Control**.  
The Manual Control Window is displayed.
8. Select the **Data Collection** page from the Tree.  
The Window updates with the Data Collection page.
9. Set the **Wavelength** to **0 nm** and click **Apply**.
10. By holding a piece of matt white paper behind each cell holder, visually examine the light spot to see that the radiation beam is passing through the cell sample area.
11. Light scattering become apparent if the radiation beam impinges on the cell wall.
12. If the radiation beam is not centered exactly, loosen the two locking screws and the two milled posts on the relevant cell holder and shift the cell holder plate to center the radiation beam horizontally.  
Then retighten the two milled posts and the two locking screws.
13. Now visually check the vertical alignment of the radiation beam in the cell sample area.  
Alignment is correct when the radiation beam is just above the floor of the cell sample area (min. 2 mm) or covers the cell window.



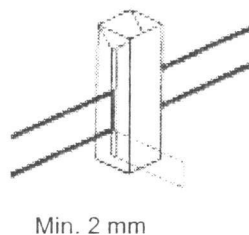

**Figure 11 Correct Alignment of the Radiation Beam in the Cell Sample Area**

**NOTE:** *The center of the window for micro flowcells should ideally be approximately 15 mm above the base of the cell.*

14. If vertical alignment is required, turn the vertical adjustment screw on the lifter either clockwise to raise the cell, or counter-clockwise to lower the cell.
15. Recheck the horizontal alignment of the radiation beam through the cell and correct if necessary.
16. From the Tools menu in UV WinLab Explorer select **Manual Control**. The Manual Control Window is displayed.
17. Select the **Data Collection** page from the Tree. The Window updates with the Data Collection page.
18. Set the **Wavelength** to any value above **200 nm** and click **Apply**.
19. Remove the card blocking the sample beam window and close the sample compartment cover.

This completes the coarse alignment of the cell holder. If necessary, proceed with the fine alignment as described below.

### ***Fine Alignment***

For semi-micro and micro cells we recommend that a fine alignment is performed.

If fine alignment is necessary, proceed as follows:

1. From the Tools menu in UV WinLab Explorer select **Manual Control**.  
The Manual Control Window is displayed.
2. Select the **Data Collection** page from the Tree.  
The Window updates with the Data Collection page.
3. Set the **Wavelength** to your measurement wavelength or to **460 nm**.
4. Select **%T** (transmission) as the Ordinate mode and click **Apply**.
5. Open the sample compartment cover.
6. Insert the cell with a low absorbing solvent into the sample cell holder.
7. Leave the reference cell holder empty.
8. Make horizontal fine alignment to the sample cell holder (locking screws and milled posts loosened) to obtain the highest possible transmittance reading on the display (close sample compartment cover while measuring transmittance).
9. Make vertical fine adjustment using the vertical adjustment screw again to obtain the highest possible reading (close sample compartment cover while measuring transmittance).
10. When you are satisfied with the alignment, tighten the milled posts and the locking screws on the cell holder.
11. Insert the matching cell with the same low absorbing solvent into the reference cell holder.

**NOTE:** *The first cell remains in the sample cell holder.*

12. Repeat steps 5 to 9 with the reference cell holder, but this time obtain the lowest possible transmittance reading on the display.



This completes the fine alignment procedure.

**NOTE:** *When the cell holder has been aligned once, you can take it out and reinstall it without aligning it again.*

### Minimum Volume Applications

To measure minimum sample volumes, use common PerkinElmer cells.

The minimum sample volume required is specified below

Cell Type		Cell Internal Width	Pathlength	Minimum Volume Required	Part Number
	Height of liquid slightly more than height of beam	2 mm	1 cm	200 $\mu\text{L}$	B0631071 (pair)
		4 mm	1 cm	400 $\mu\text{L}$	B0631064 (pair)
		Cell Volume	Pathlength	Minimum Volume Required	Part Number
	Cell window completely filled with liquid	0.5 $\mu\text{L}$	0.01 cm	2 $\mu\text{L}$	B0631082
		2.5 $\mu\text{L}$	0.5 cm	5 $\mu\text{L}$	B0631080
		5 $\mu\text{L}$	0.1 cm	10 $\mu\text{L}$	B0631083
		5 $\mu\text{L}$	1.0 cm	10 $\mu\text{L}$	B0631081
		30 $\mu\text{L}$	1.0 cm	50 $\mu\text{L}$	B0631079

**NOTE:** You should align microcells very carefully in the radiation beam by following the procedures in *Aligning the Single Cell Holder* on page 60. When aligning microcells, fill each cell with the minimum volume of liquid specified in the above table to make sure that the liquid meniscus is not in the radiation beam.

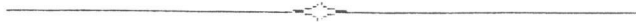

# *Accessories* **5**

---

## ***Operating with Accessories***

---

### ***General***

Accessories are components, or instruments, that are installed or connected in the sample compartment, or otherwise connected to the spectrometer. For some of these accessories, parameters have to be taken into account in the UV WinLab methods.

When the accessories described below are connected to the instrument, they will be detected automatically and the UV WinLab software will display the required fields to operate with the accessory.

### ***Accessories***

The following accessories are currently detected by UV WinLab:

Changers	Single Cell Holder, Peltier thermostatted 9 Cell Changer, Peltier thermostatted 13 Cell Changer, Peltier thermostatted
Linear Transporter	With 8 cell holder With 5 cell (long pathlength) holder With 6 cell holder
Sippers	Peristaltic Sipper
Sensors	Temperature Sensor

## **Requirements for Operation with Accessories**

The following preconditions must be fulfilled in order to operate with accessories:

- The accessory in use must be activated on the accessory page of the UV WinLab software.
- The connector panel for the accessory in question must be installed in the spectrometer.

Some accessories, such as Peltier cell holder and 9 cell Peltier changer require an upgrade board fitted to the power supply unit.



## Accessory Connections

To operate the spectrometer with some accessories, for example the Peltier Temperature sensor, an accessory panel kit (L6000500) is required.

### Accessory Connector Panel

A common connector panel is used for the Lambda Series of instruments.

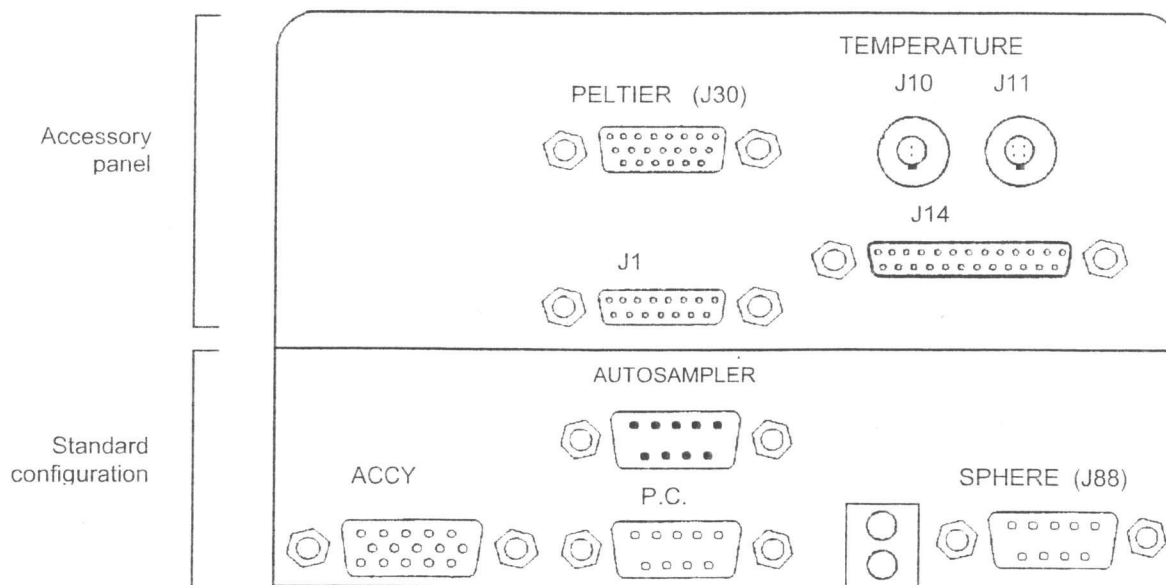

Figure 12 Accessory Connector Panel

Designation	Connector for	Remarks
Accessory Port (Accy)	Linear transporter, multi-sipper	I <sup>2</sup> C-bus interface
PC	PC,	RS 232 C interface
J10, J11, Temp	Temperature sensor	J10: 2-pin socket J11: 4-pin socket
J30, Peltier	Peltier cell changer and Peltier cell holder	Active
J88, Sphere	Integrating Sphere	Active

## Accessory Connections Overview

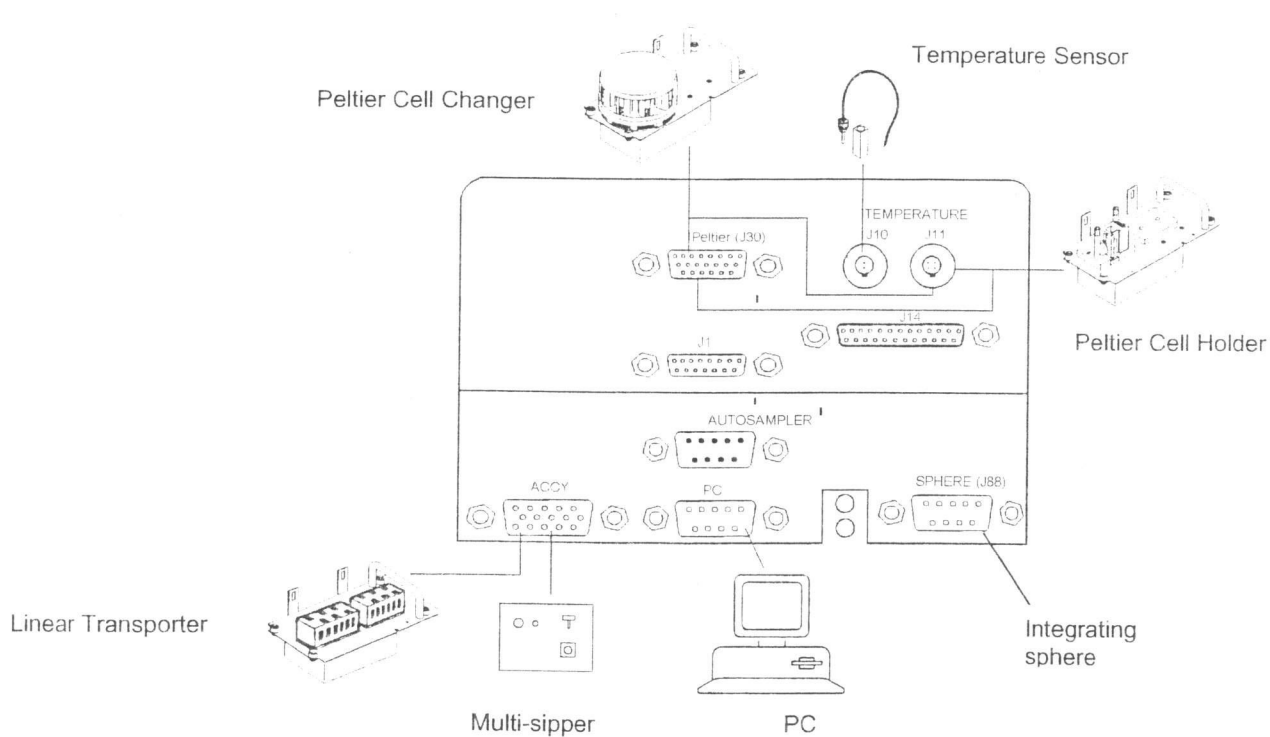

Figure 13 Accessories for the Lambda 25, 35, 45

### Accessory Installation

Some of the accessories used with the spectrometer require removal of the sample compartment cover.

### **Sample Compartment Cover**

To remove the sample compartment cover do this carefully as follows:

1. Open the cover to 90 degrees to the sample compartment.
2. Carefully slide the cover straight up off both hinges to remove.

To install the sample compartment cover, or other accessory cover, perform this procedure in reverse.

### **Sample Compartment Front Cover**

Some of the accessories used with the spectrometer require removal of the sample compartment front cover.

Do this carefully as follows:

1. Open the sample compartment cover.
2. Loosen the two screws securing the front cover of the sample compartment.
3. Slide the front cover forwards and remove from the spectrometer.

To install the sample compartment front cover, perform this procedure in reverse.

### **Sample Compartment Window**

To remove or install certain accessories, you need to remove the sample compartment windows. There are four in total (2 each for samples and references).

Each window has a magnetic frame and should be carefully removed by hand.

## Linear Transporter



**WARNING**

### **Electrical hazard**

*To prevent potential injury to yourself and damage to the instrument, switch OFF all instruments in the system and disconnect them from the line power supply before you alter, or make any new, electrical connections.*

### **Installation Overview**

Connector on Spectrometer:	<b>Accessory Port (Accy)</b>
Installation:	See linear transporter manual
Cables:	Lead through bottom of spectrometer housing
Tubes:	Lead through the tube ports
Sample Compartment Cover:	Unchanged
Alignment:	See linear transporter manual

## Temperature Sensor



**WARNING**

### **Electrical hazard**

*To prevent potential injury to yourself and damage to the instrument, switch OFF all instruments in the system and disconnect them from the line power supply before you alter, or make any new, electrical connections.*

### **Installation Overview**

**NOTE:** *When connecting the temperature sensor, align the red mark on the plug with the red mark on the socket.*

*Pull the collar on the plug back to connect/disconnect the plug. Release the collar to secure the plug (see Figure 12, page 71).*

Connector on Spectrometer:	<b>Temp J10</b>
Cables:	Lead through the tube ports
Sample Compartment Cover:	Unchanged

## Sippers



**WARNING**

### Electrical hazard

To prevent potential injury to yourself and damage to the instrument, switch OFF all instruments in the system and disconnect them from the line power supply before you alter, or make any new, electrical connections.

### Installation Overview

Connector on Spectrometer:	<b>Accessory Port (Accy)</b>
Installation:	See Sipper manual
Cables:	See Sipper manual
Tubes:	See Sipper manual
Sample Compartment Cover:	Unchanged

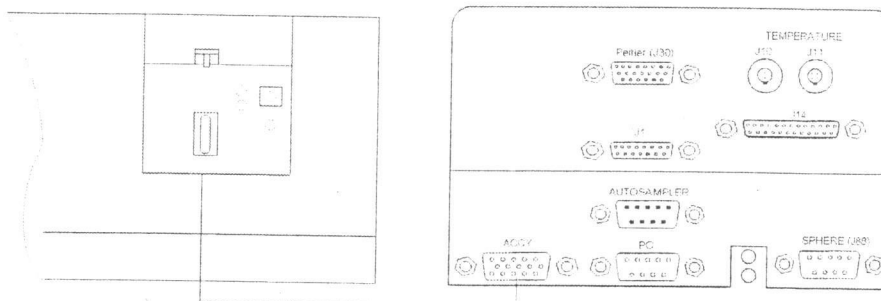

B0167808

Figure 14 Sipper, electrical connection

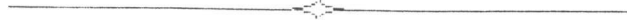



*Maintenance* **6**

---

## **Maintenance**

---

### **Obtaining Service**

All servicing of the instrument not covered in this chapter should be performed by a PerkinElmer service representative.

Please contact your local PerkinElmer sales or service office to obtain service.

The instrument is constructed with high quality components and requires little maintenance other than to keep it clean and free of dust.



**WARNING**

#### **Unauthorized Adjustments and Servicing**

*Do not attempt to make adjustments, replacements or repairs to this instrument except as described in the accompanying User Documentation.*

*Only a PerkinElmer service representative or similarly trained and authorized person should be permitted to service the instrument.*



**WARNING**

*Switch off the instrument before cleaning any spilled materials.*

To protect the optical system from dust and fumes, you should keep the sample compartment cover closed except for when you are carrying out work in the compartment.

You should observe the following care routine to maintain your instrument in good condition:

- Immediately clean all spilled materials from the affected area and wipe it dry with lint-less paper or cloth.  
If the sample compartment windows have to be wiped, make sure scratches are not introduced.  
Sample windows are optical components and you should handle them in the same way as high quality cells.
- Do not leave samples, particularly those given to fuming or evaporation, in the sample compartment for longer than necessary. Samples of a volatile nature are included as well.
- If any type of sample handling system is installed and portions of it are left in the sample compartment (such as a sipper and flowcell), make certain that the system is cleaned at the end of the working day and filled with deionized water when left overnight.

**CAUTION**

***Risk of damage to Optics or Electronics***

*Take care not to spill liquids onto the spectrometer. Expensive damage can result to the optics or electronics if liquids are spilled and run inside the instrument.*

## ***Cleaning the Sample Compartment***

You must clean the sample compartment every time anything is spilled into it. This preserves the matt black finish, and prevents corrosion and contamination.

The standard sample compartment baseplates have drain holes in them to run off spilled liquids to the benchtop underneath the instrument. You can place a sheet of thick filter paper under the instrument, if required.

1. First remove the cell holder or other sample handling accessory from the sample compartment.
2. Using a soft cloth and mild laboratory detergent solution, lightly scrub away all foreign material.
3. Using a clean cloth dampened with water, rinse the cleaned surfaces thoroughly.
4. Dry with lint free cloth or tissue.

## ***Sample Compartment Window***

Windows are provided with the spectrometer. The window is made of silica and may be used in the entire spectral range of the spectrometer.

The window seals the sample compartment and thus protects the instrument's optics from dust and fuming or aggressive samples.

- Leave the window installed, unless an accessory requires them to be removed.
- The window is an optical component and requires the same care and handling as cells. Refer to page 84 for more information.
- You can remove the window to clean it. The frame is magnetic and can be removed by hand.

Windows are most suitably cleaned by wiping them with a soft cloth moistened with ethanol.

## ***Use and Care of Cells***

---

### ***Cell Handling***

A good spectrometer cell is an optical device, forming a part of the optical system of the instrument with which it is used. It must be accorded the same careful treatment applied to any optical component. Optical faults of a minor nature, for example, scratches, lint, fingermarks, on the optical surfaces can easily introduce substantial analytical errors.

You should observe the following list of cell handling rules to prevent analytical errors and to achieve utmost precision:

- Only hold cells by non-optical surfaces, such as the matt finish surfaces.
- Protect cells from scratches, and never permit them to rub against one another or against other hard surfaces.
- Avoid abrasive, corrosive or stain-producing cleaning agents, and make certain that the exposed surfaces of cells are optically clean.
- Always wipe the optical surfaces of cells dry, using a soft cloth or cleaning tissue, just before placing them in the cell holder. The optical surfaces of the cells, should also be free from finger marks.
- When measuring cold solutions, always bear in mind that condensation can form on the external surfaces of the cell.
- Make certain no bubbles cling to the inner surfaces of the cell, particularly when measuring cold solutions.
- For maximum precision and accuracy, calibrate and test with cells of the same type, and always insert cells into the holders with the same orientation.

## ***Pressure Buildup in Cells***

If you are using stoppered cells, observe the following rules to prevent the buildup of internal pressure that could cause the stopper to pop-out of the cell.

- Only fill the cell so full that the liquid meniscus is just above the radiation beam. The remaining air space in the cell is then adequate to compensate for any slight increase in pressure in the cell during routine operation.
- If, for analytical reasons, it is necessary to fill the cell completely, insert the stopper only lightly so that the liquid in the cell has a chance to expand.
- Do not insert a stopper forcefully into a completely filled cell since this is likely to cause the stopper to pop-out of the cell.
- When working at higher temperatures, use a drilled stopper (0.4 mm hole) to allow for expansion in the cell.

## Replacing a Lamp

Lamp compartment cover

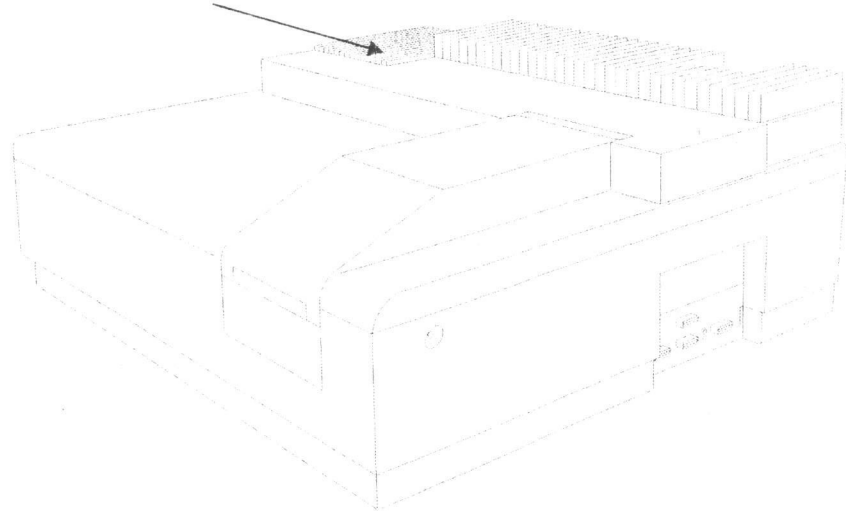

Figure 15 Lamp compartment

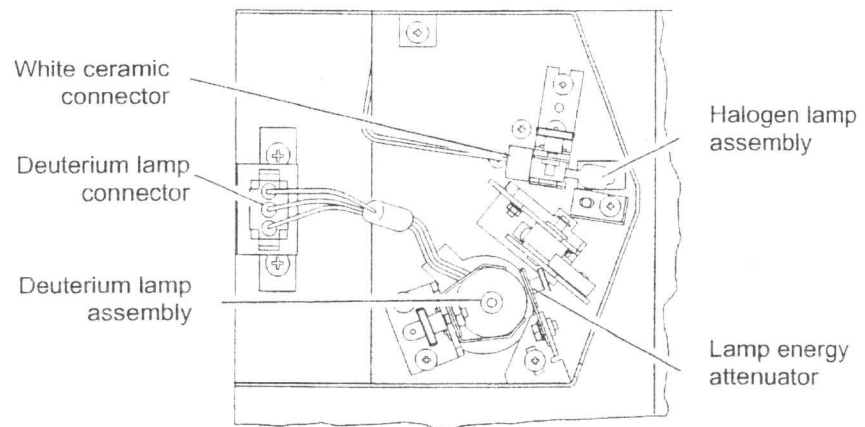

Figure 16 Inside the Lamp Compartment (Baffle removed)

## Halogen Lamp Replacement

If the lamp burns out, or if the bulb becomes blackened after prolonged use, you should replace the lamp.

Replacement lamp assemblies are provided complete with pre-aligned mounts (Part Number B0114620).

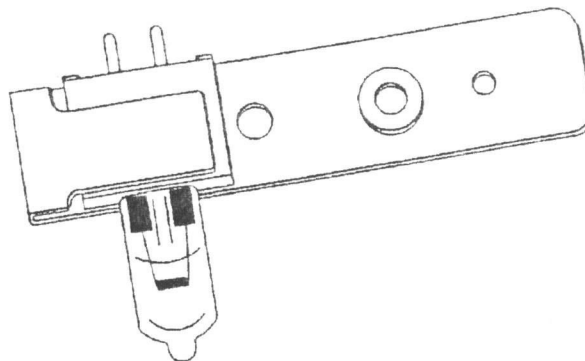

Figure 17 Pre-aligned Halogen Lamp (B0114620)



WARNING

### **Electrical Hazard**

*Switch off the spectrometer and remove the plug from the electrical supply before starting with the replacement.*

### **Risk of Burns**

*If the old lamp was lighted: allow it to cool before proceeding with the replacement.*

### **UV Radiation**

*The lamps emit intense radiation which can damage your eyes.  
Do not open the lamp compartment when the lamps are on.  
Do not gaze into a lighted lamp.*



1. Switch off the spectrometer and unplug the line power cord.
2. Remove the lamp compartment cover as shown in Figure 15 on page 86, by pressing down the catch and pushing the cover to the left.
3. Remove the lamp baffle by slackening the socket head cap screw for the deuterium lamp and lifting the lamp baffle vertically upward.

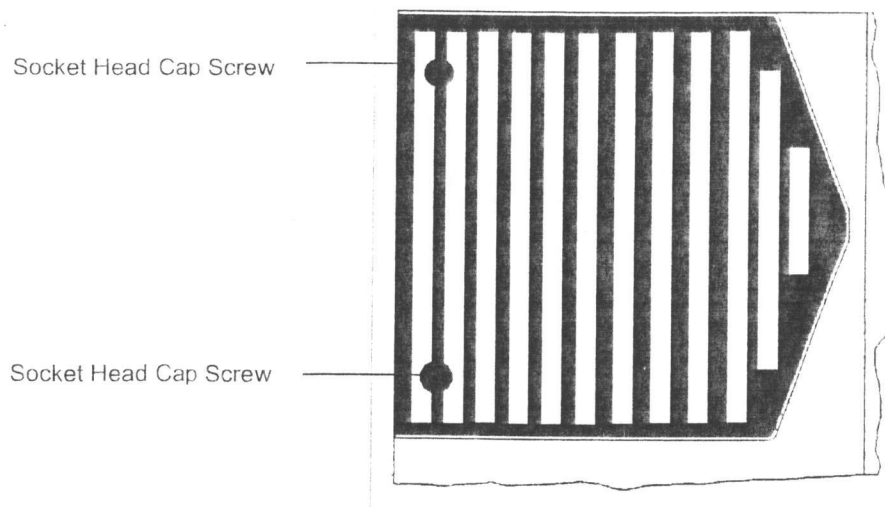

**Figure 18 Lamp baffle**

4. Carefully pull the white ceramic connector from the rear of the halogen lamp.

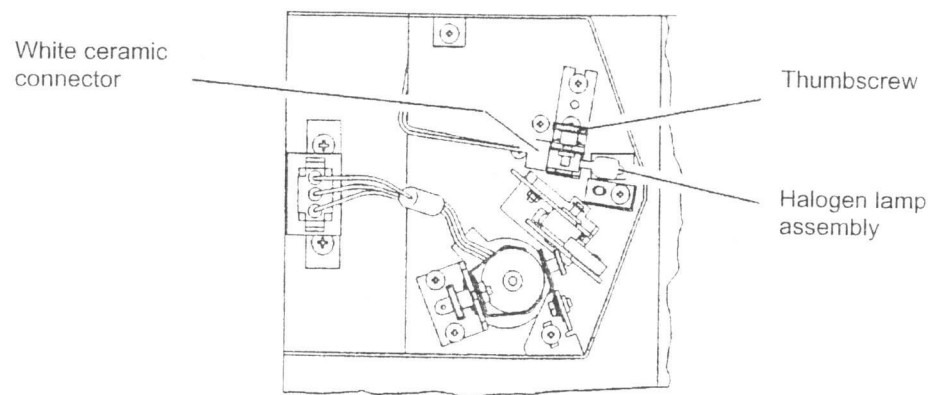

**Figure 19 White ceramic connector**

5. Remove the lamp assembly from the bracket by slackening the thumbscrew and pulling the lamp mount vertically upward.  
Save the thumbscrew for use with the new lamp assembly.
6. Unpack the new lamp assembly, taking care to hold it only by the metal mount to prevent fingermarks on the bulb.
7. Slip the slot at the base of the lamp mount over the stud on the bracket in the lamp compartment and then secure with the thumbscrew.
8. Carefully push the ceramic connector firmly onto the pins on the base of the lamp.
9. Wipe the bulb with a soft cloth moistened with alcohol to remove dirt, since this would otherwise be burned in when the lamp is hot.
10. Replace the lamp baffle using the reverse of the procedure described in step 3.
11. Replace the lamp compartment cover.

This completes the halogen lamp replacement procedure.

## Deuterium Lamp Replacement

If the lamp burns out, or indicates falling energy after prolonged use, you should replace the lamp.

Replacement lamp assemblies are provided complete with pre-aligned mounts (Part Number B0160917).

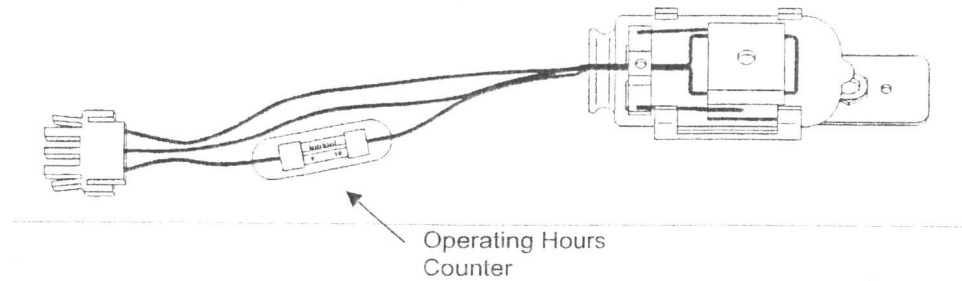

**Figure 20 Pre-aligned Deuterium Lamp Assembly (B0160917)**

**NOTE:** *An operating hour counter is incorporated in the red deuterium lamp lead. By means of a gap between the two display bars it is possible to read off the number of hours that the lamp has been in operation. One scale division corresponds to approximately 100 hours. You should switch off the instrument before reading the operating hours counter.*



**WARNING**

### **Electrical Hazard**

*Switch off the spectrometer and remove the plug from the electrical supply before starting with the replacement.*

### **Risk of Burns**

*If the old lamp was lighted: allow it to cool before proceeding with the replacement.*

### **UV Radiation**

*The lamps emit intense radiation which can damage your eyes.*

*Do not open the lamp compartment when the lamps are on.*

*Do not gaze into a lighted lamp.*

1. Switch off the spectrometer and unplug the line power cord.
2. Remove the lamp compartment cover as shown in Figure 15 on page 86, by pressing down the catch and pushing the cover to the left.
3. Remove the lamp baffle by slackening the socket head cap screws and lifting the lamp baffle vertically upward.

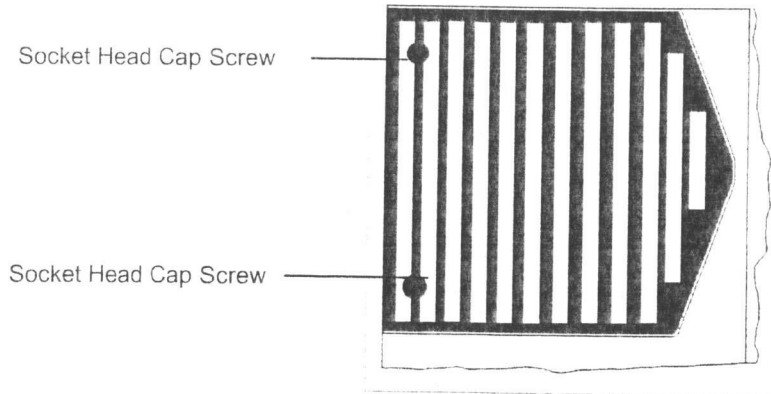
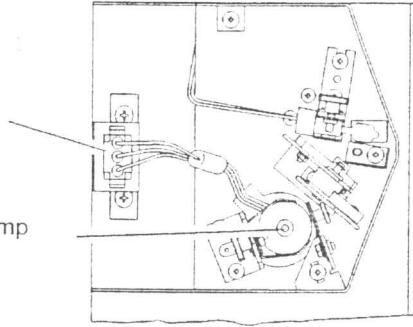

**Figure 21 Lamp baffle**

4. Unplug the deuterium lamp connector from the terminal board by squeezing in the two lugs at each side of the connector and carefully pulling the connector vertically upward.

Deuterium lamp  
connector

Deuterium lamp  
assembly



**Figure 22 Deuterium lamp connector**

5. Remove the lamp assembly from the bracket by slackening the thumbscrew and pulling the lamp mount vertically upward. Save the thumbscrew for use with the new lamp assembly.
6. Unpack the new lamp assembly, taking care to hold it only by the metal mount to prevent fingerprints on the lamp window.
7. Slip the slot at the base of the lamp mount over the stud on the bracket in the lamp compartment and then secure with the thumbscrew.
8. Plug the deuterium lamp connector into the socket.

**NOTE:** *The socket in the lamp compartment is asymmetric; the deuterium lamp connector can be inserted in one direction only. Make certain that the connector is the right way round before inserting it. Never attempt to insert the connector by force.*

9. Wipe the lamp window with a soft cloth moistened with alcohol to remove dirt, since this would otherwise be burned in when the lamp is hot.
10. Replace the lamp baffle using the reverse of the procedure described in step 3.
11. Replace the lamp compartment cover.

This completes the deuterium lamp replacement procedure.

## Lamp Energy Attenuator

An attenuator is located in the lamp compartment between the deuterium lamp and the beam entrance slit.

If required you can decrease or increase the energy by placing the attenuator into, or taking the attenuator out of, the beam.

The attenuator is set at the factory, normally in the out position.



**WARNING**

### **Electrical Hazard**

*Switch off the spectrometer and remove the plug from the electrical supply before starting with the replacement.*

### **Risk of Burns**

*If the old lamp was lighted: allow it to cool before proceeding with the replacement.*

### **UV Radiation**

*The lamps emit intense radiation which can damage your eyes.*

*Do not open the lamp compartment when the lamps are on.*

*Do not gaze into a lighted lamp.*

Operate the attenuator as follows:

1. Remove the lamp compartment cover as shown in Figure 15 on page 86, by pressing down the catch and pushing the cover to the left.
2. Remove the lamp baffle by slackening the socket head cap screws and lifting the lamp baffle vertically upward.

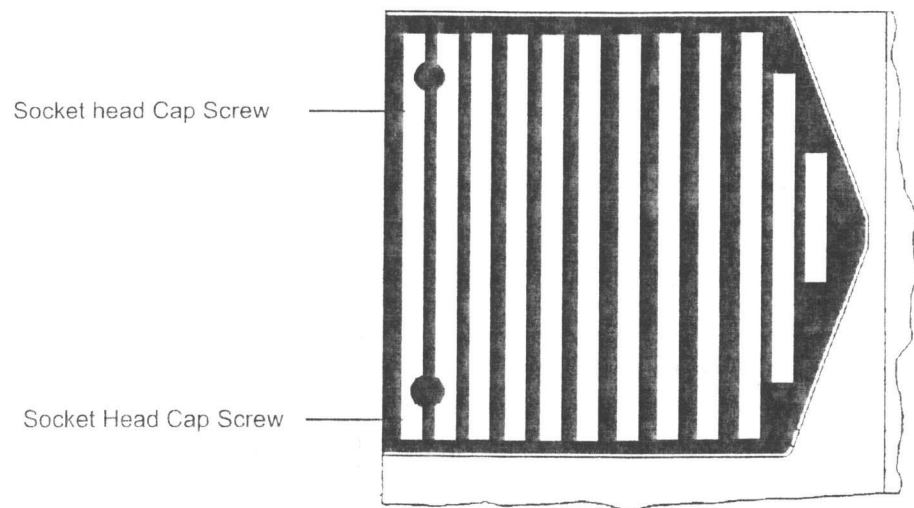

Figure 23 Lamp baffle

3. Loosen the thumbscrew holding the attenuator in place.

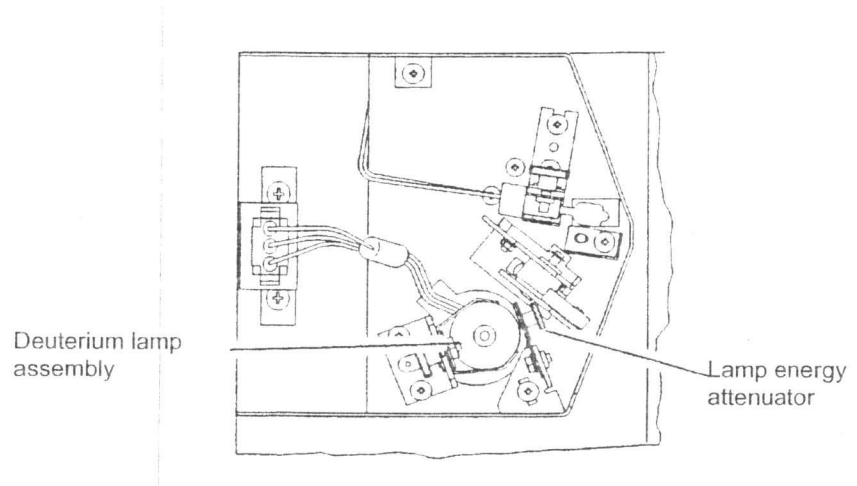

Figure 24 Deuterium lamp assembly

4. Slide the attenuator downwards into the beam.
5. Tighten the thumbscrew.  
Follow the above procedure in reverse to slide the attenuator out of the beam.
6. Replace the lamp baffle using the reverse of the procedure described in step 2.
7. Close the lamp compartment.

### ***Lamp Alignment Procedure***

Due to the pre-aligned mounts, the alignment of lamps after installation is generally so good that further alignment is not required.



## Changing Fuses

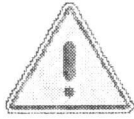

**WARNING**

### **Electrical hazard**

*To prevent potential injury to yourself and damage to the instrument, switch OFF the instrument and disconnect it from the line power supply before you change the fuses.*

The fuses are located in a fuse holder at the rear of the instrument:

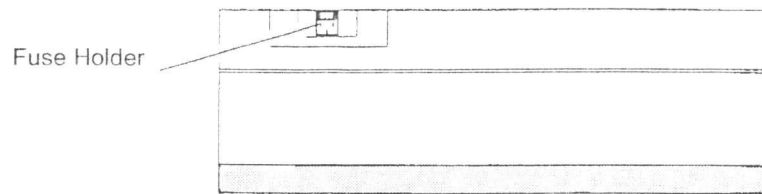

**Figure 25** Rear view, fuse holder

1. Switch off the instrument and remove the line power cord from the electrical supply.
2. Squeeze the two lugs at each side of the fuse holder and gently pull out.

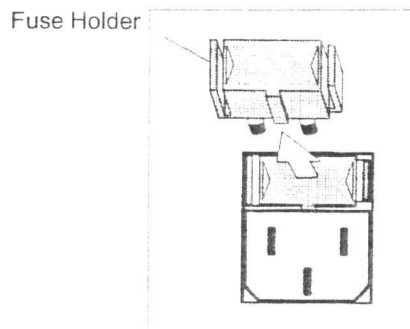

**Figure 26** Removing the fuse holder

3. Replace the spent fuse with a new one of the same type and rating:

Voltage	Standard
100 V – 240 V	3.15 A T, 250 V

**NOTE:** *The module has two fuses. Although only one fuse may have blown both fuses should be replaced at the same time.*

4. Replace the fuse holder.

Align the lug at the bottom of the fuse holder with the slot in the socket. A click is heard as each lug snaps into place.

**NOTE:** *If you use the correct fuses but the instrument still does not work correctly, or the fuses blow repeatedly, contact your PerkinElmer office or representative.*

## **Replacement Parts**

---

Supplies, accessories, and replacement parts can be ordered directly from PerkinElmer. e-ssentials, PerkinElmer's catalog service, offers a full selection of high-quality ultraviolet supplies or a copy is available on the software utilities CD or on-line at [www.instruments.perkinelmer.com/catalog](http://www.instruments.perkinelmer.com/catalog)

<b>Quantity</b>	<b>Item</b>	<b>Part Number</b>
10	3.15 A slow-blow fuse	B0155573
1	Deuterium Lamp, prealigned	B0160917
1	Halogen Lamp, prealigned	B0114620
1	Thumbscrew for lamp mount	09920684
1	Sample Compartment Window	B0098757
1	Single Cell Holder	B0505071

*Analytical Notes* **7**

---

## ***Unusual Samples***

---

If a sample is chemically stable and undergoes no physical or chemical change other than to absorb incident radiation, errors in photometric values should not be caused by the sample. Many samples are not stable, and special consideration must be given to them.

### ***Volatile Samples***

Some liquid samples are so volatile that their concentration can change while recording is in progress. If this occurs, the resulting data will lack reproducibility.

If you are analyzing volatile samples, use stoppered cells to prevent this problem.

### ***Samples not Governed by the Beer-Lambert Law***

Quantitative analyses utilizing the absorption of spectral radiation are based on the Beer-Lambert law which states that the absorption is proportional to the concentration of the analyte.

The law can be expressed in the form

$$A = \epsilon c d$$

Where:

**A** is absorbance

$\epsilon$  is molar absorption coefficient

*c* is molar concentration

*d* is thickness through which the radiation is transmitted

This law is mostly true for dilute solutions, but at higher concentrations a plot of absorbance against concentration will be non-linear for a number of reasons.

The absorption characteristics of a sample can be changed during sample preparation, depending on the amount of reagent added for color development and so on. For details, refer to reference books covering these subjects.

Temperature has an influence to a greater or lesser degree on the absorption characteristics of a sample. You should check this effect if non-repeatable results are obtained.

If you are measuring temperature-dependent samples, either wait until temperature equilibrium has been attained or use a thermostatted cell or cell holder.

### ***Chemically Reactive Samples***

If a reaction takes place in the cell between the sample material and the solvent, spectral data based on that sample cannot always be expected to have sufficient reliability or repeatability.

For samples of this type, use a quantitative method that takes advantage of the change in transmittance with time at a fixed wavelength. For details, refer to reference books covering this specific subject.

### ***Photoactive Samples***

Some samples are known to be photoactive in that they fluoresce upon absorbing radiation. Since a small portion of the fluorescent radiation will be measured by the detector, a higher apparent transmittance will often result.

Samples are also known that undergo photochemical reactions as they absorb radiation. With such samples, which are mostly biochemical, lack of reproducibility will characterize the resultant data.

### ***Other Sample Properties***

Samples that are polarizing in nature, or have a double index of refraction, are often difficult to measure accurately. The emerging monochromatic radiation is slightly polarized due to having been refracted.

Thin-film samples also pose a problem since optical interferences may develop, causing a regular interference pattern to be superimposed on the spectral curve.

## ***Solvent Properties***

---

The solvent should meet the following requirements:

- It should dissolve the sample without reacting with it.
- The radiation absorption in the scanning region should be low.  
High absorption by the blank reduces the reference energy, thus increasing noise.
- Evaporation should be fairly low at ambient temperature.

In general, aromatic compounds exhibit high absorption in the UV region and hence are not suitable as solvents for measurements in this region.

Water is virtually the only useful solvent below 195 nm, but it must be freed from oxygen to attain best transmission.

Whenever you are going to use a solvent with unknown absorption characteristics, scan its spectrum first to determine whether it is suitable.

The lower wavelength limits of a number of commonly used solvents are presented in the following table.

The lower limit has been defined as that wavelength at which 10 mm of pure solvent has a transmission of 10%.

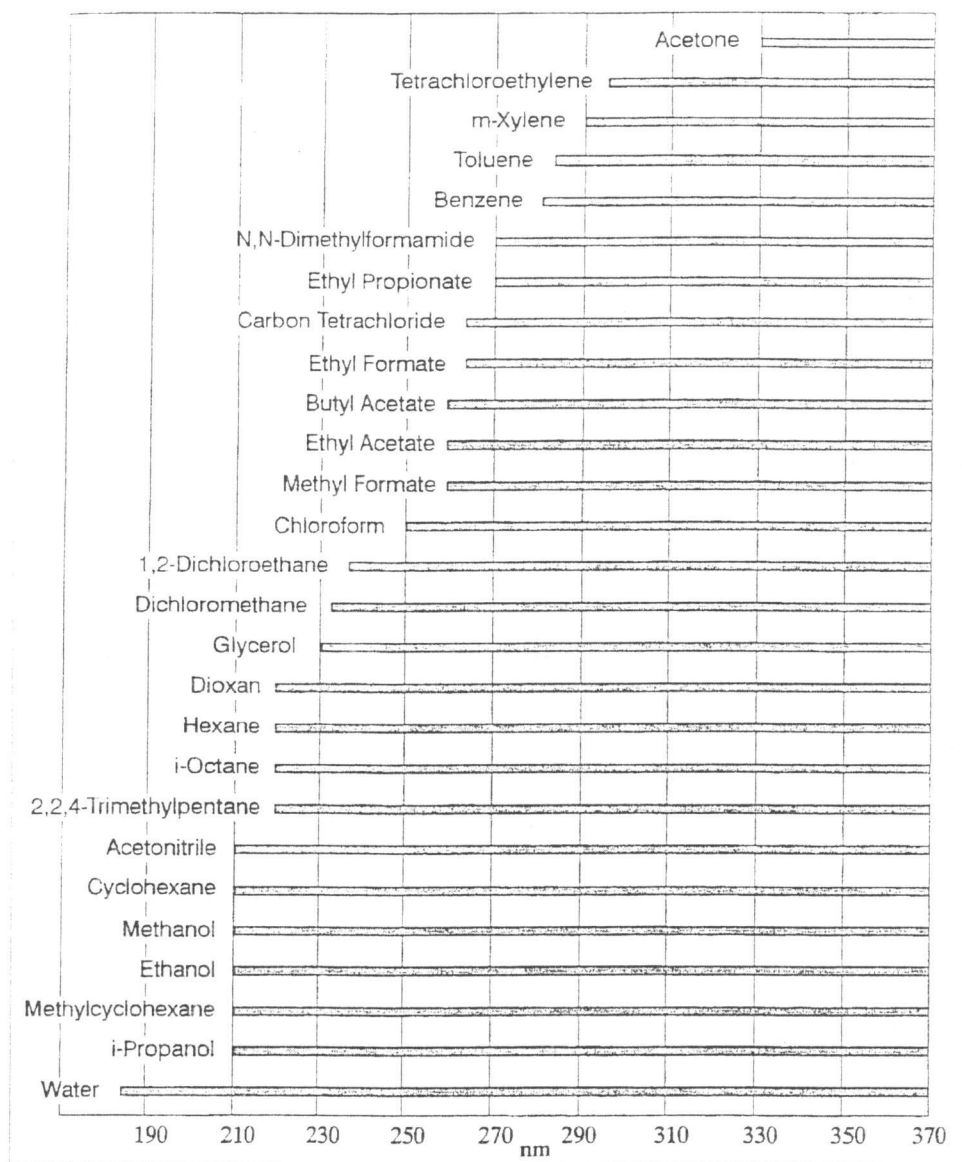

Figure 27 Lower Wavelength Limits of Solvent



# *Index*

---

## Index

---

### A

Accessories, 69  
 Accessory Connections, 73  
 Accessory Installation  
   Linear Transporter, 75  
   Multi-sippers, 77  
   Temperature Sensor, 76  
 Attenuator, 93

### C

Conventions  
   Notes, cautions and warnings, 35  
   text, 35

### F

Fuses  
   Changing, 96

### I

Installation  
   Single Cell Holder, 58  
   Unpacking and Inspection, 51  
 Installation Summary, 47  
 Introduction, 37

### L

Labels, 18  
 Laboratory Preparation, 48  
 Laboratory Space Requirements, 49  
 Lamp  
   Replacing, 86  
 Lamp Alignment, 95  
 Lamp Replacement  
   Deuterium, 90  
   Halogen, 87  
 Lifting the instrument, 17  
 Linear Transporter, 75

### M

Maintenance  
   Changing Fuses, 96  
   Cleaning the Sample Compartment, 83  
   Daily Care, 81  
   Obtaining Service, 81  
   Use and Care of Cells, 84  
 Multisippers, 77

### O

Operating with Accessories, 69

### P

Preparing Your Laboratory, 48  
   laboratory space, 49

### R

Replacement Parts, 98  
 Requirements for Operation with Accessories,  
   70

### S

Safety  
   Summary, 9  
 Safety information, 9  
   Electromagnetic Compatibility (EMC), 13  
 Safety Information  
   CSA Compliance, 9  
   Electrical Protection, 9  
   Electrical Safety, 10  
   Environment, 14  
   IEC 1010 Compliance, 9  
 Sample Compartment  
   Cover, 74  
   Window, 74  
 Solvent Properties, 103  
 Startup and Shutdown, 55

*Lambda 25, 35, 45 User's Guide*

System Description  
major components, 38  
Optical System, 39

Lambda 25, 42

**U**

Unusual Samples, 101

**T**

Technical Data



**PerkinElmer**<sup>®</sup>  
precisely.

**PerkinElmer Life and Analytical Sciences**

US - 710 Bridgeport Avenue  
Shelton, CT 06484-4794, U.S.A.

Europe - Chalfont Road, Seer Green, Beaconsfield,  
BUCKS, HP9 2FX, United Kingdom

Internet: <http://www.perkinelmer.com>  
e-mail: [life@perkinelmer.com](mailto:life@perkinelmer.com)